

INTRODUCTION

# **VOLVO PENTA**

# **WORKSHOP MANUAL**

## **MD21A - MD32A**

## **AQD21A - AQD32A**

### **marine diesel engines**

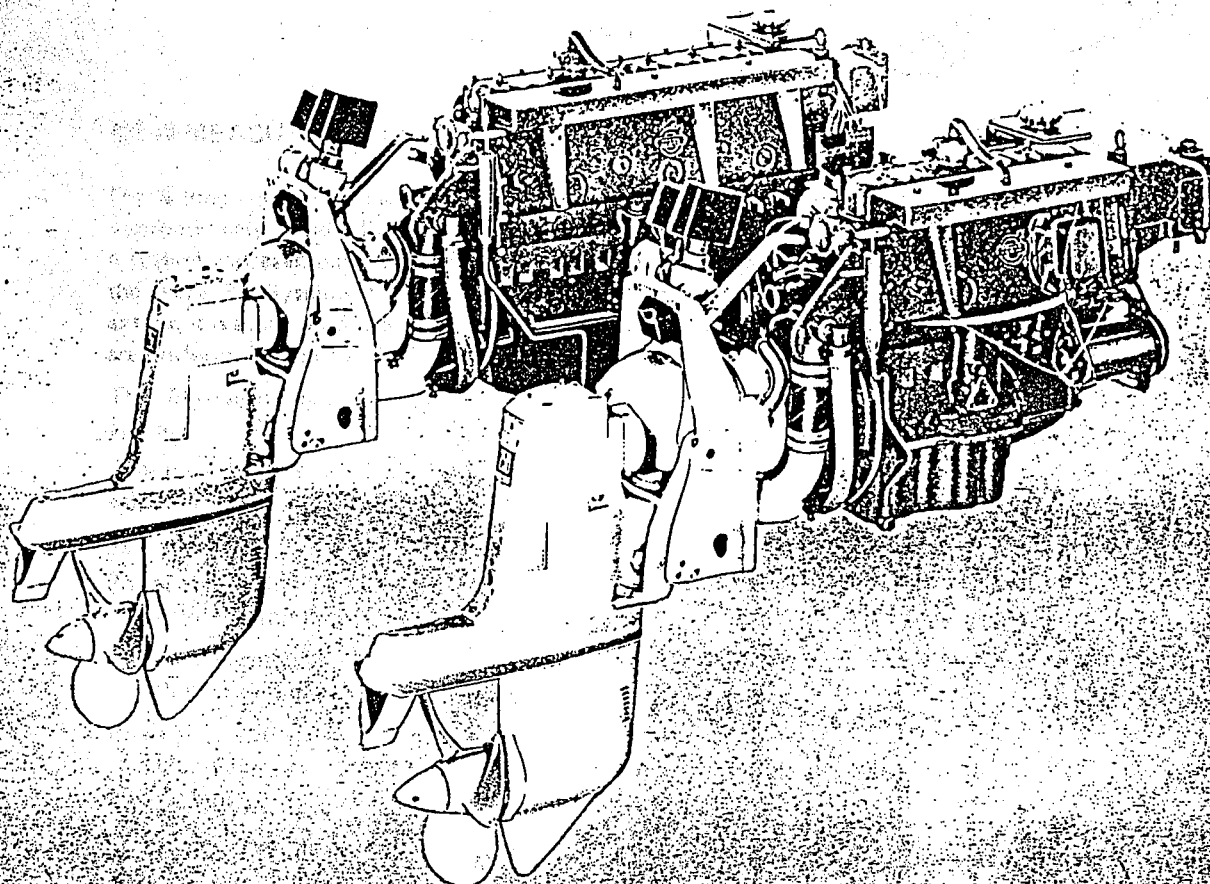

ENGINE UNIT

## INTRODUCTION

This workshop manual contains descriptions of repair work on the MD21A, AQD21A, MD32A and AQD32A marine diesel engines.

Since there are differences between the various models, as far as optional equipment is concerned, it is important that you state the engine type and serial number when ordering spare parts or in correspondence.

The instructions in this manual describe the most suitable repair methods assuming the use of certain special tools, listed under the heading "Special Tools".

We reserve the right to make alterations in design and for this reason the contents of this manual are not binding.

AB VOLVO PENTA

Technical Information Dept.

## NEW MEASUREMENTS UNITS

For a long time technicians have endeavoured to find an internationally standardized system of measurements. Such a system was eventually established in 1960 and was given the name SI (Système International d'Unités). To a great extent, it is based on previous systems, except that the units are uniform, i.e., no conversions are needed.

The European industry is now starting to use this SI-system.

The new SI-units are included in this book. Units used earlier are given within brackets.

The units are:

Power is given in kW (kilowatt)

Previous unit h.p. (horsepower)

Torque is given in Nm (Newtonmetre)

Previous unit kpm (kilopondmetre)

Engine revolutions are given in r/s (revolutions per second)

previous unit r.p.m. (revolutions per minute)

Volume is given in dm<sup>3</sup> (cubic decimetre)

Previous unit l (litre)

## CONTENTS

|  |       |
|--|-------|
| Presentation .....                           | 2-5   |
| <b>Removing</b>                              |       |
| Electrical system, exhaust manifold .....    | 6     |
| Sea-water pump, fuel injection pump .....    | 7     |
| Heat exchanger .....                         | 8-9   |
| Fresh-water pump .....                       | 9     |
| Cylinder head, timing gears .....            | 10    |
| Lubricating oil pump, camshaft .....         | 11    |
| Connecting rods, crankshaft, liners .....    | 12    |
| <b>Fitting</b>                               |       |
| Crankshaft .....                             | 13    |
| Cylinder liners, pistons .....               | 14    |
| Piston rings .....                           | 15    |
| Lubricating oil pump, crankshaft drive ..... | 16    |
| Cylinder head, valves .....                  | 17-21 |
| Sea-water pump .....                         | 22-23 |
| Circulation pump, feed pump .....            | 24-25 |
| Adjusting fuel injection pump .....          | 26-28 |
| Injections, glow plugs .....                 | 28-29 |
| Oil cooler .....                             | 30    |
| Fuel filter, exhaust elbow .....             | 31    |
| Wiring diagram: Engine .....                 | 32    |
| Wiring diagram: Instrument panels .....      | 33    |
| Special tools .....                          | 34-35 |
| Technical Data .....                         | 36-39 |

# Presentation

MD 21 A

4-cyl. - 75 h.p.

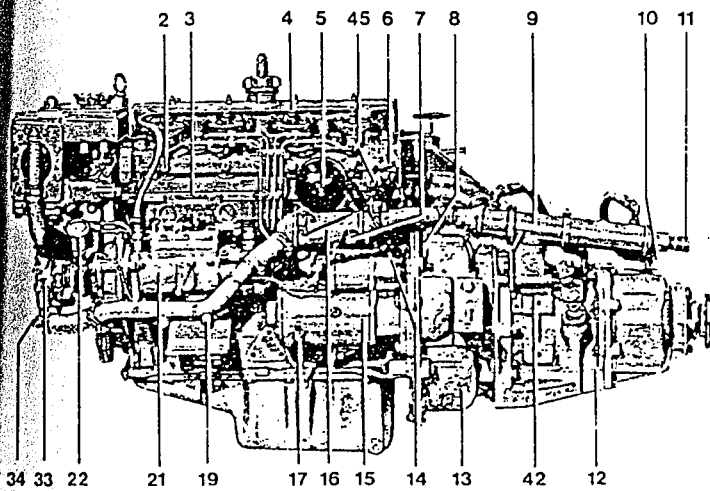

Port side, MD 21 A with Borg-Warner reverse gear

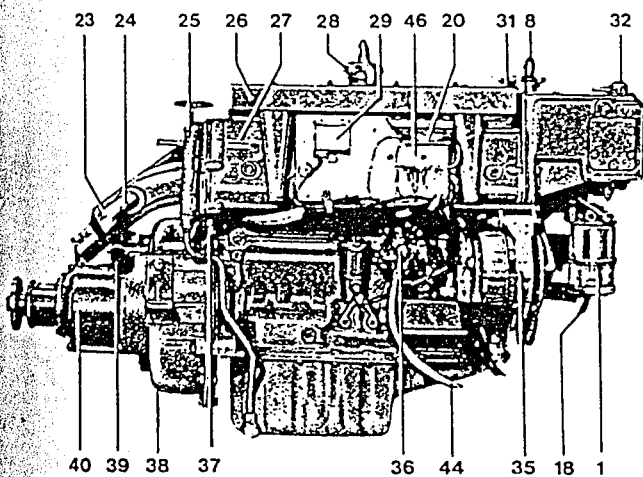

Starboard side, MD 21 with RB reverse gear

1. Water-separating fuel filter
2. Glow plug
3. Engine number
4. Injector
5. Lubricating oil filter
6. Sender - temperature gauge
7. Sender - oil pressure gauge
8. Lift eyelet
9. Oil cooler, reverse gear
10. Drain plug for cooling water
11. Connection, sea water
12. Reverse gear, Borg-Warner
13. Flywheel housing
14. Drain plug, fresh water (located on block)
15. Starter motor
16. Oil cooler, engine
17. Oil dipstick
18. Return to fuel tank
19. Drain point for sea water
20. Fusing
21. Fuel injection pump
22. Sender - rev counter
23. Water-cooled exhaust elbow
24. Separate water outlet
25. Oil scavenging pump
26. Intake silencer
27. Water-cooled exhaust manifold combined with intake manifold
28. Oil filler cap
29. Charging regulator
30. Filler cap, fresh water
31. Filler cap, fresh water
32. Connection to expansion tank
33. Sea-water pump
34. Drain plug, sea water
35. Alternator or dynamo
36. Feed pump with hand primer
37. Drain cock, sea water
38. Drain plug, sea water
39. Connection, sea water
40. Reverse gear type RB
41. Alternator
42. Type designation, reverse gear
43. Zinc plug (inside cover)
44. Fuel line to feed pump
45. Glow plug resistor
46. Glow plug relay

MD 32 A

6-cyl. — 106 h.p.

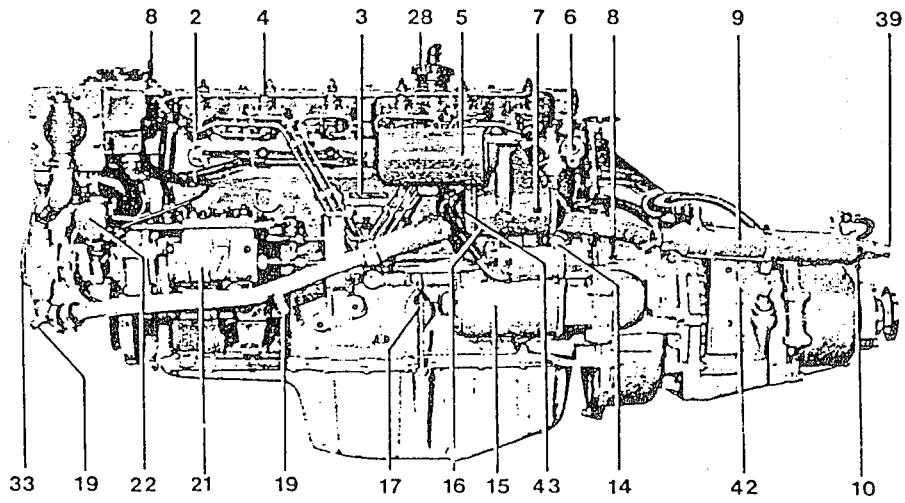

Port side, MD 32 A with Borg-Warner reverse gear  
See page 2 for explanation of numbers

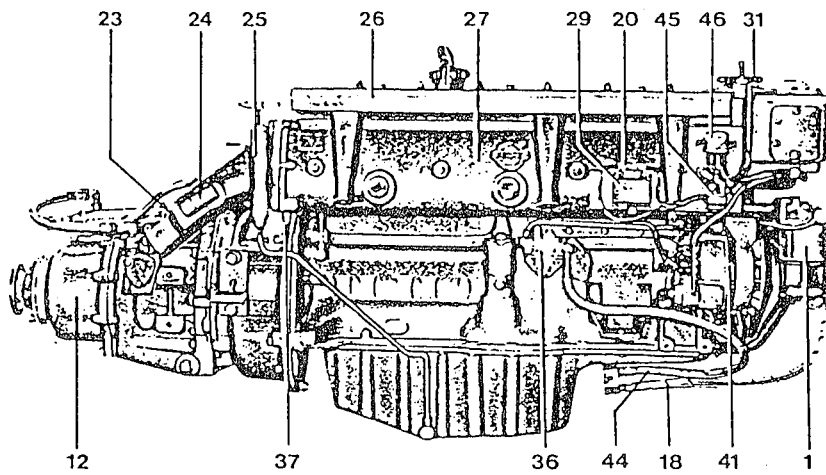

Starboard side, MD 32 A with Borg-Warner reverse gear  
See page for explanation of numbers

AQD 21A/270D

4-cyl. - 75 h.p.

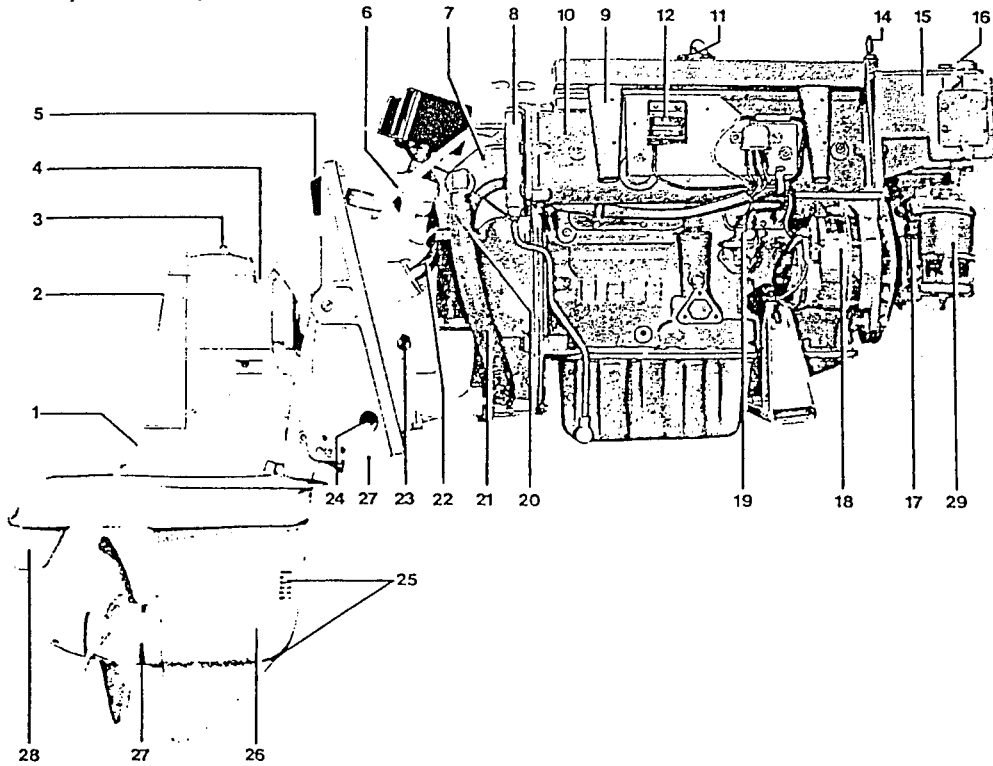

Starboard side, AQD 21A/270D

See page 5 for explanation of numbers

AQD 32A/270D

6-cyl. - 106 h.p.

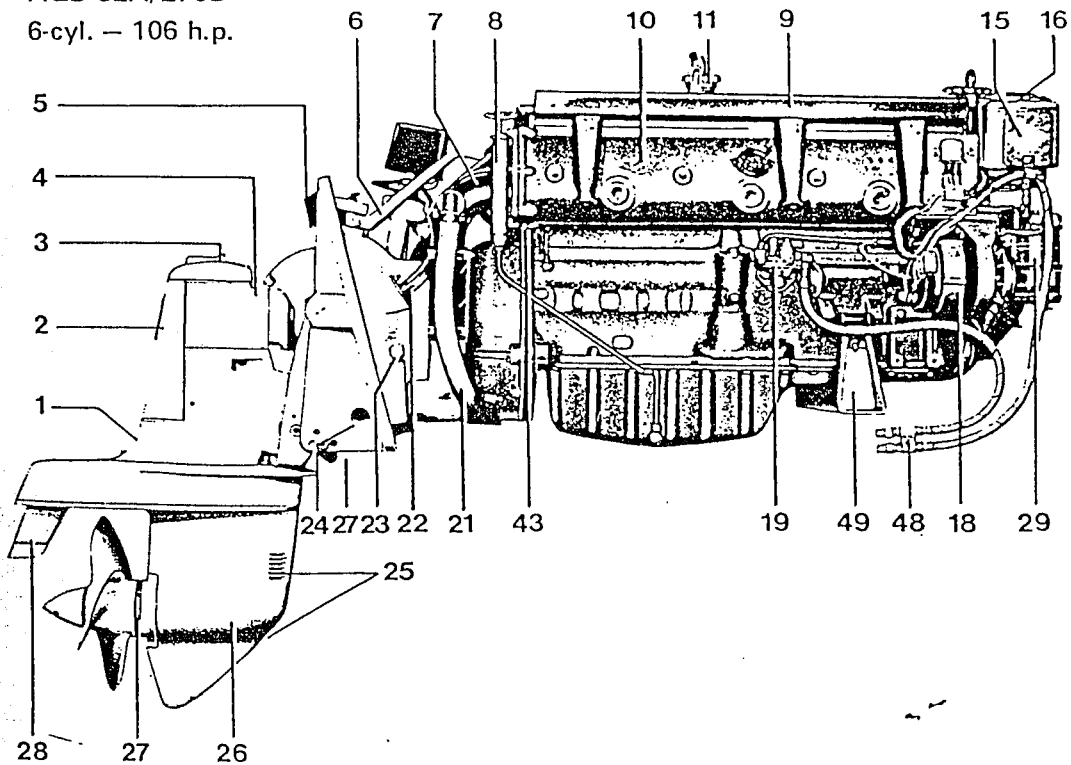

Starboard side, AQD 32A/270D

See page 5 for explanation of numbers

AQD 21 A  
4-cyl. — 75 h.p.

1. Oil filler cap
2. Cover for gear mechanism
3. Oil dipstick
4. Serial production number
5. Rubber block
6. Steering arm
7. Water-cooled exhaust elbow
8. Oil scavenging pump
9. Intake silencer
10. Water-cooled exhaust manifold with intake manifold
11. Oil filler cap
12. Charging regulator
13. Connection board
14. Lift eyelet
15. Heat exchanger
16. Overpressure valve
17. Sea-water pump
18. Alternator
19. Feed pump with hand primer
20. Lubricator (located on flywheel housing)
21. Surplus water hose
22. Cooling water
23. Plug for gear cable grommet
24. Outlet, surplus water
25. Cooling water intake
26. Outboard drive model 270D
27. Corrosion protection
28. Exhaust outlet with trimming lab
29. Fuel filter with water separator
30. Filler cap, cooling water
31. Glow plug
32. Serial production number
33. Injector
34. Oil filter
35. Oil pressure sender
36. Temperature gauge sender
37. Type data plate
38. Elec. mechanical drive lift
39. Flexible casing
40. Mounting collar
41. Plug for gear cable grommet
42. Flywheel housing
43. Drain cocks (on block, exh. man., suction line)
44. Starter motor
45. Oil cooler
46. Oil dipstick
47. Type data plate
48. Connector for fuel lines
49. Front support member
50. Fuel injection pump
51. Sender for rev counter
52. Plug, heat exchanger

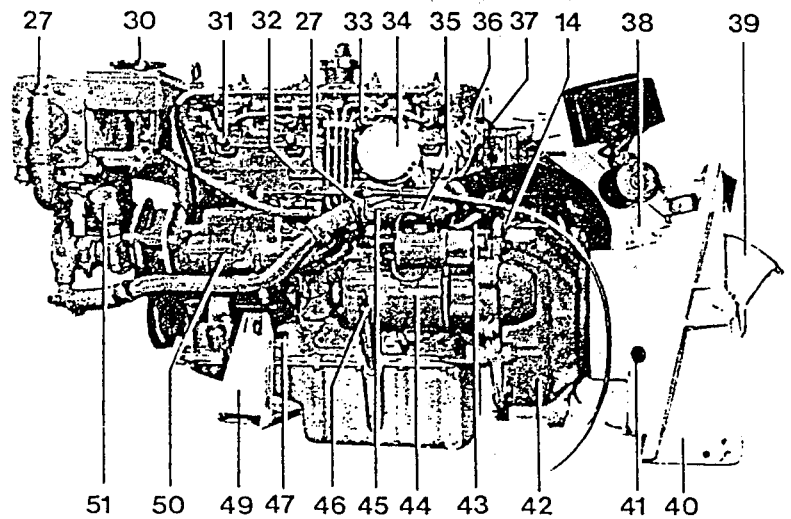

Port side, engine unit AQD 21 A

AQD 32 A  
6-cyl. — 106 h.p.

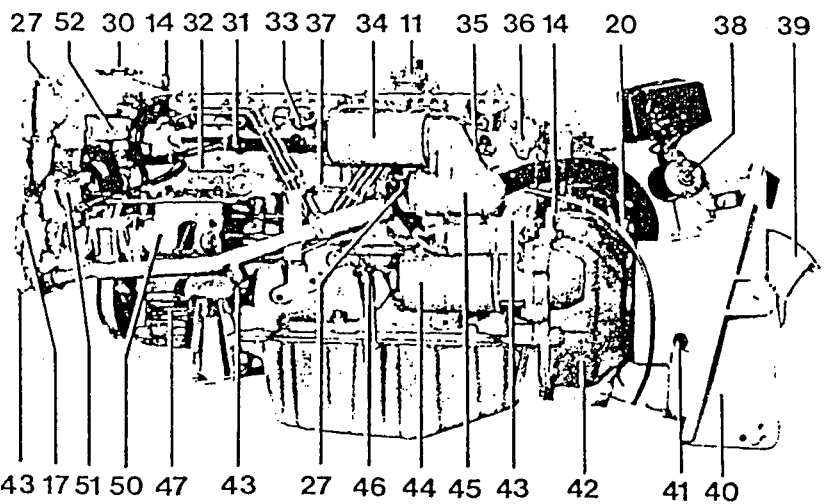

Port side, engine unit AQD 32 A

# Repair Instructions

Drain the cooling water and the oil from the engine; then clean the outside of the engine.

## Removing

Electrical system, exhaust manifold

Remove the following parts: the alternator ground cable, the cable for the engine speed sender, the charging regulator and the nuts for the attaching plate, the drive belt for the alternator and the alternator, the clamps for the cable harness, the cables from the starter motor, the cable for the water temp. sender in the cylinder head and the cable for the oil pressure in the oil cooler.

Remove the intake silencer and the hose from the oil filler cap.

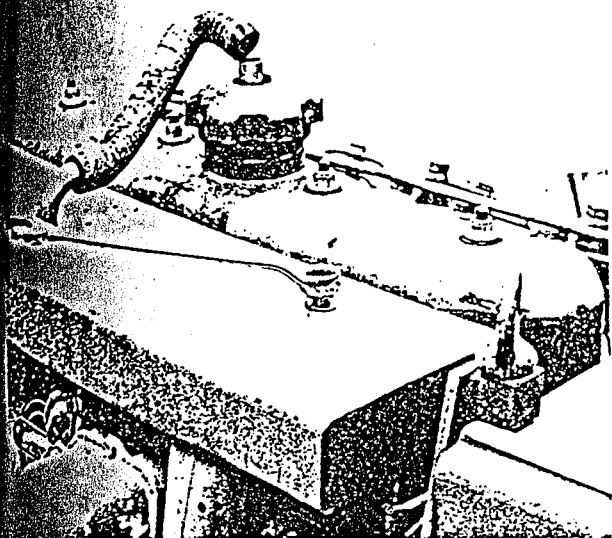

3. Remove the bolts that are locked with lock wire on the exhaust manifold (exhaust elbow — heat exchanger). Release the other bolts and nuts on the exhaust manifold and pull off the manifold from the studs.

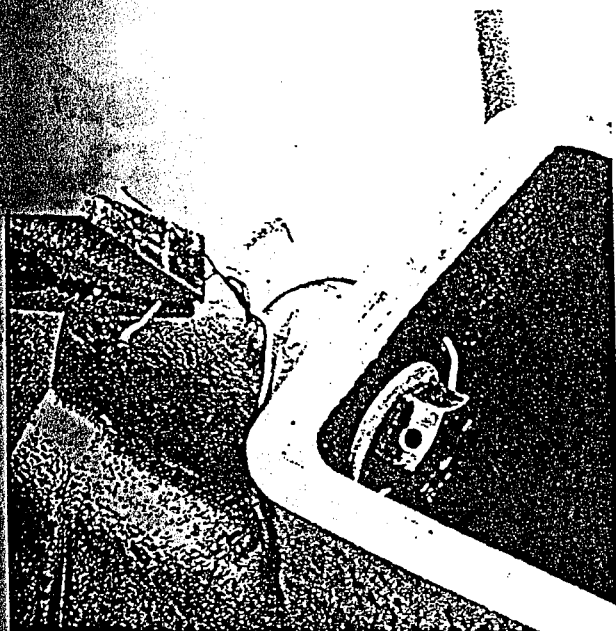

4. Remove the oil pipe for the rocker mechanism (located behind the exhaust pipe). Scrap the copper washers.

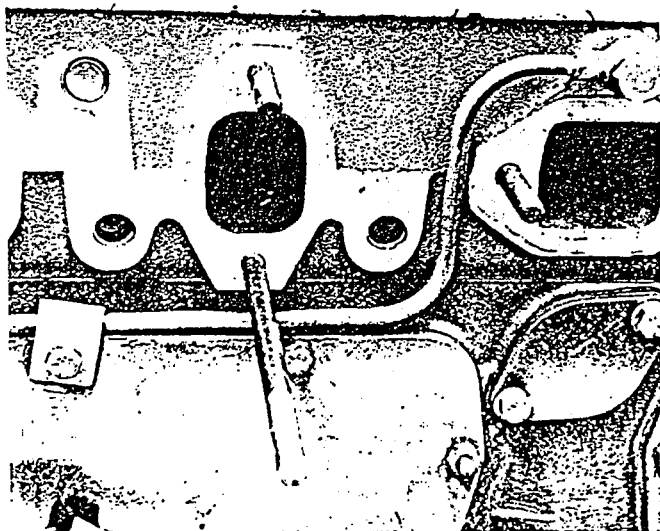

5. Remove the feed pump with fuel pipe after slackening the pipe clamps.

6. Remove the two bolts on the engine speed sender and lift up the sender.





Sea-water pump, fuel injection pump

7. Remove the sea-water pump. The bracket for the heat exchanger is released at the same time (MD21). Pull the pump straight out after the hose clamp and hose have been removed from the pump.

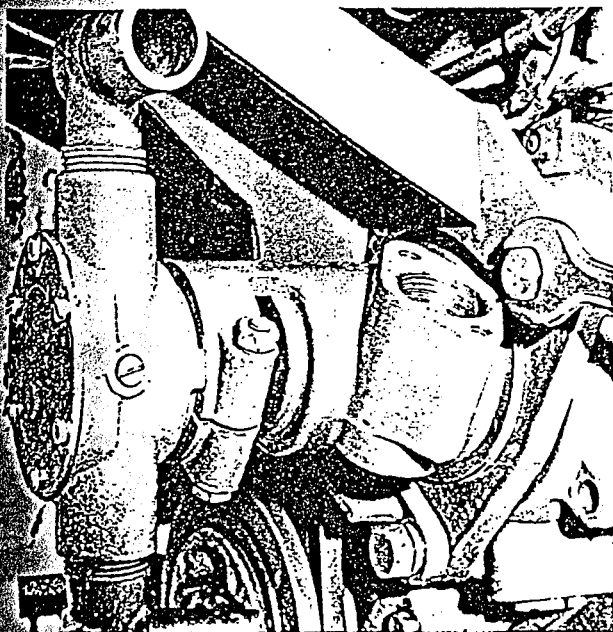

8. Remove the water pipe between the oil cooler and water pump.

9. Remove the starter motor and the drain cock on the inside.

10. Disconnect the delivery pipes from the injectors. Remove the protective caps from the spark plugs and take off the electric cable plate.

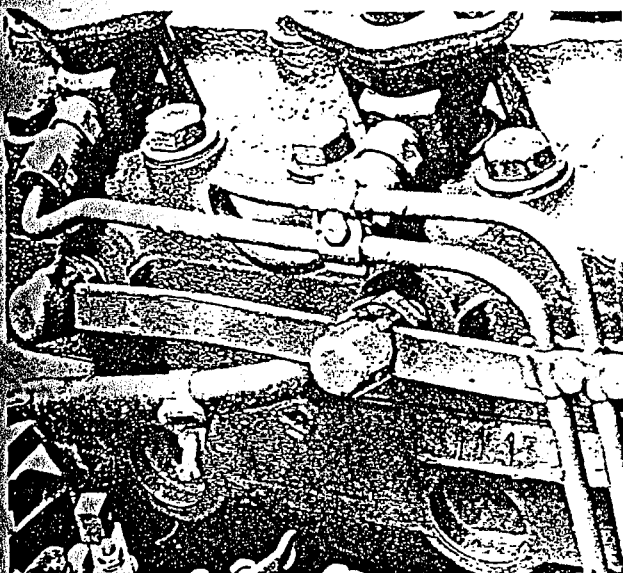

11. Remove and scrap the oil filter. Then remove the oil cooler

12. Remove the fuel injection pump and delivery pipes, also the bracket for the control. Protect the pipe ends with protective caps.

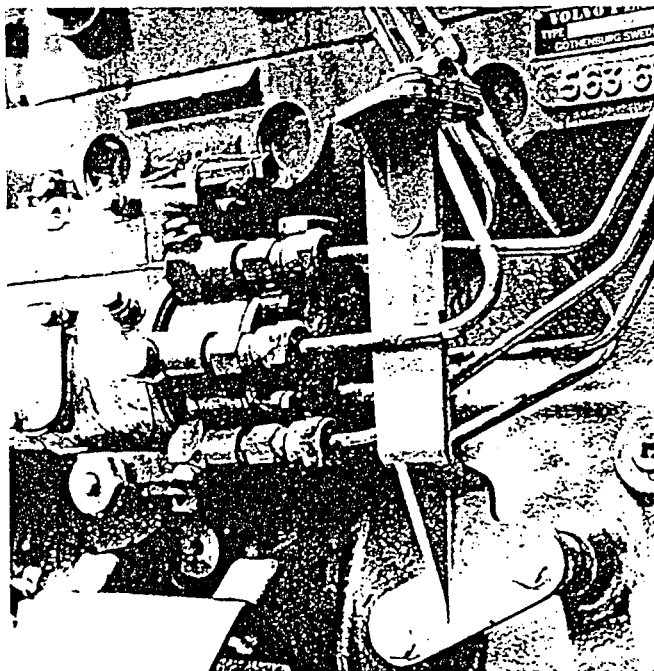

13. Remove the leak-off oil pipe from the injectors. NOTE. Scrap the copper washers. Screw back the banjo screws as a protection.

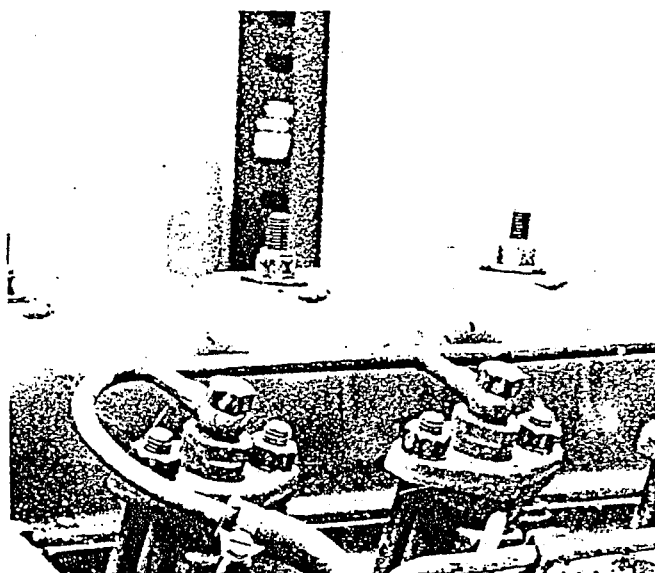

14. Remove the forks for the injectors. Then pull out the injectors. Mark them to ensure that they are replaced in the same order when installing. Fit protective caps.



15. Remove the glow plugs.

#### Heat exchanger

16. Remove the screws for the heat exchanger cover and take off the cover.

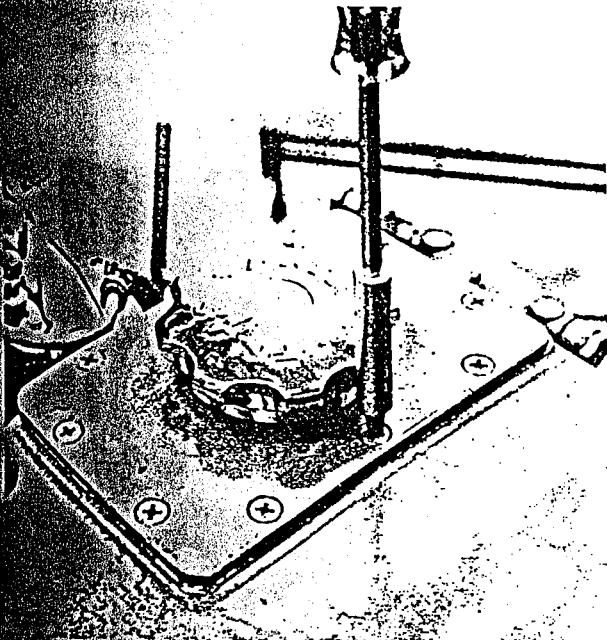

17. Undo the stainless steel nuts holding the thermostat. Remove the thermostats in order to check the opening temperature.

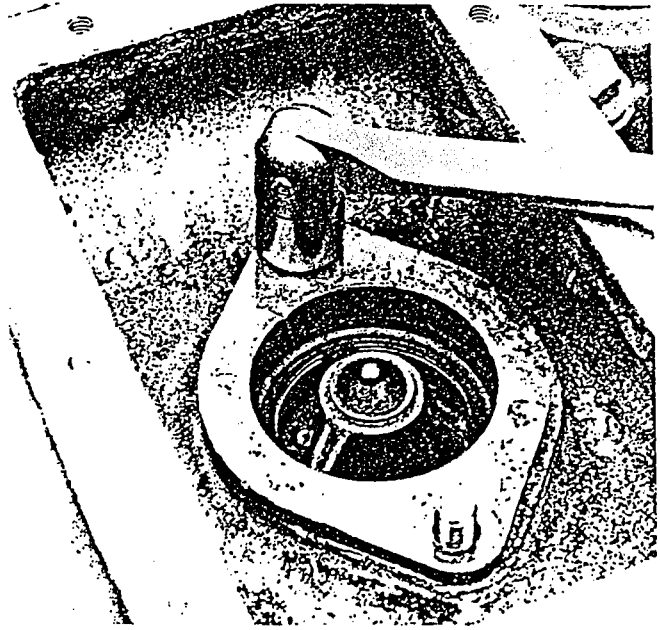

18. Release the other screws and hose clamps on the heat exchanger. Remove the hoses. NOTE. The small hose under the heat exchanger on the MD32 cannot be removed until the heat exchanger has been pulled straight up.

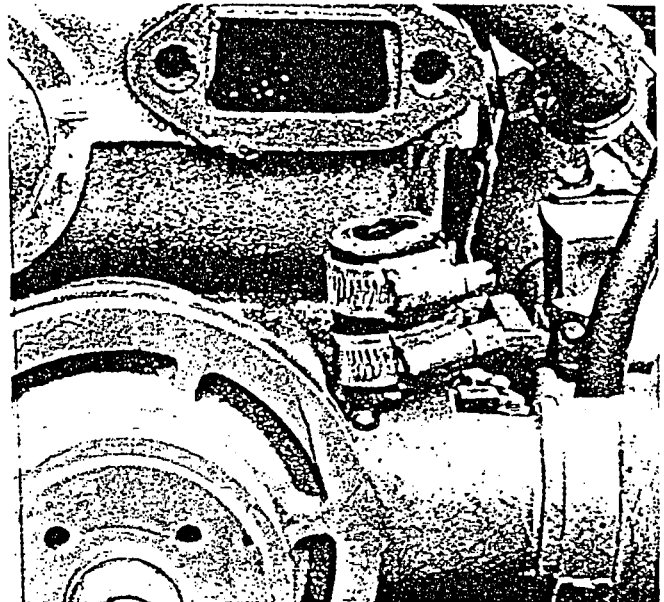

19. Remove the plate with the lift eyelet and scrap the gaskets. On late prod. type engines, the lift eyelet has been moved to the cast-iron part of the heat exchanger. The plate with gaskets between the exhaust manifold and gear exchanger is of the same design as previously, apart from the lift eyelet with the threaded attachment. The picture below shows the earlier type. The new type of plate terminates at the arrow.

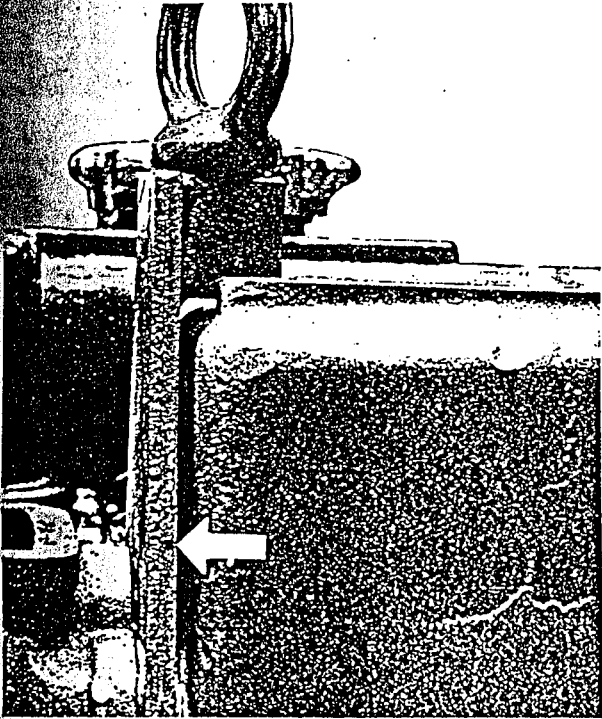

20. Remove the end cover on the port side of the heat exchanger.

21. Remove the cast iron part or end cover on the starboard side. Take out the tube insert. Remove the O-rings. Wash and blow clean all the heat exchanger parts. Check thoroughly to make sure that the tube insert channels are free from impurities. Remove the old zinc electrodes and fit new ones.

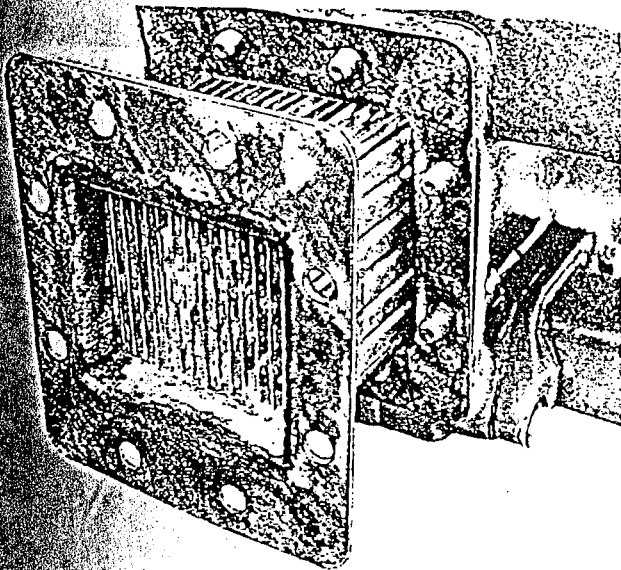

22. Fit new O-rings on the tube insert the tube insert in the heat exchanger and screw on the ends.



#### Fresh-water pump

23. Remove the water pump from the cylinder head. The pulley can be taken off after the center nut has been removed.

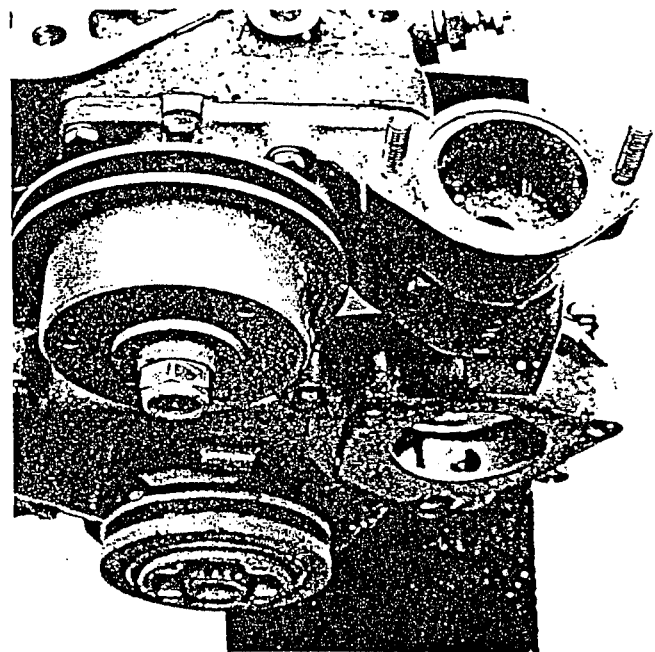

Removing the cylinder head and timing gears

Remove the rocker casing, inspection covers, valve bracket, push rods and valve lifters. Unscrew all the cylinder head bolts. NOTE. The bolts have three different lengths. Lift off the cylinder head and gasket.

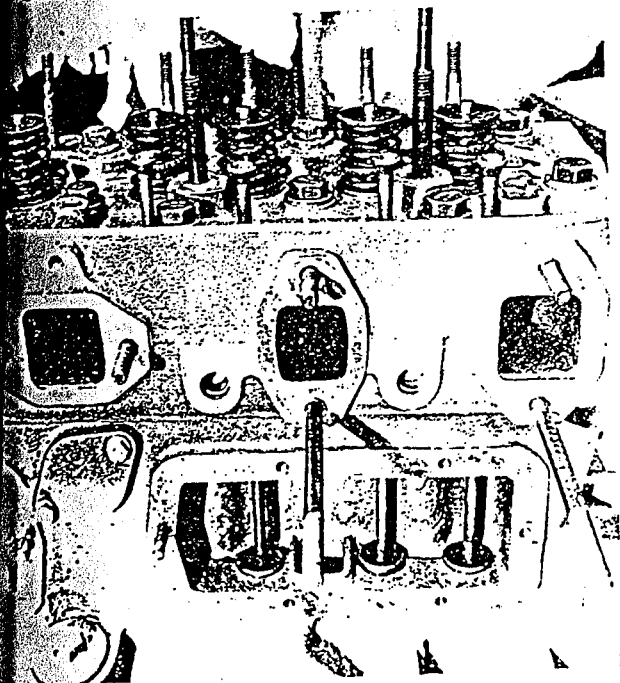

27. Remove the vibration damper from the flywheel. Remove the timing gear casing. Remove the circlip for the idler gear. Pull the idler gear straight up.

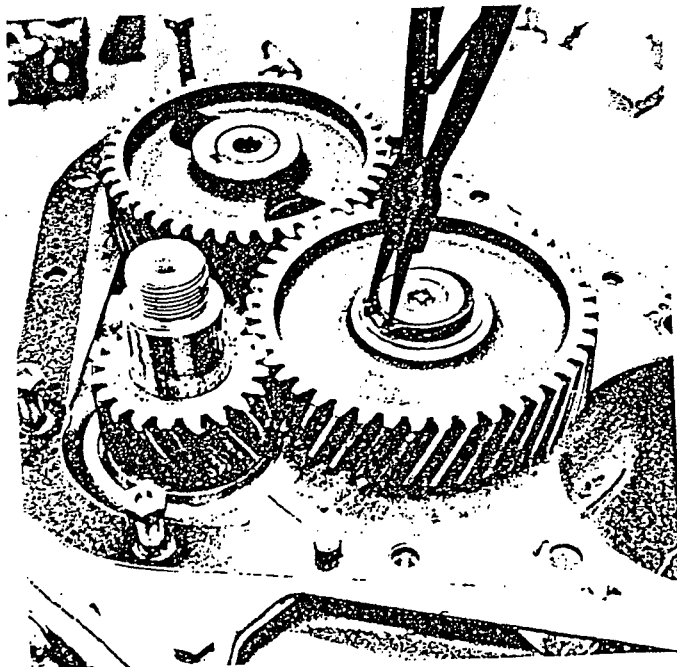

25. Remove the pipe for the oil scavenging pump. Look out for any oil remaining in the engine. Place a vessel under the pipe connection.

26. Remove the large nut on the front end of the crankshaft. Place a stop in the flywheel teeth. Pull off the pulley. NOTE. Take care of the key.

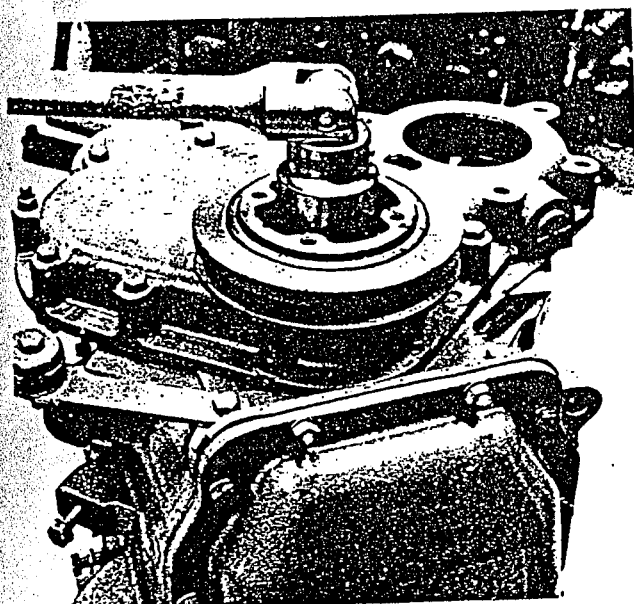

28. Knock up the tabs on the lock washer on the flywheel. Remove the bolts.

NOTE. Scrap the lock washer and bolts. Lift off the flywheel.

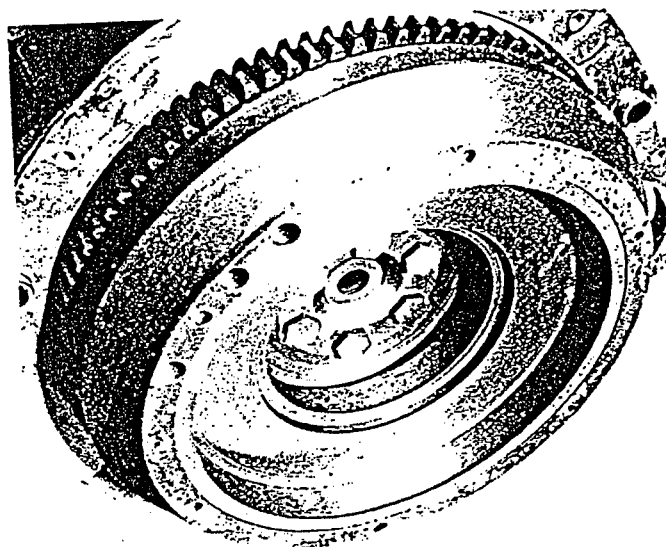

### Removing the lubricating oil pump, camshaft

29. Remove the inner flywheel casing. This casing is located by means of two guide tubes. Behind the casing there is an O-ring which must be replaced.

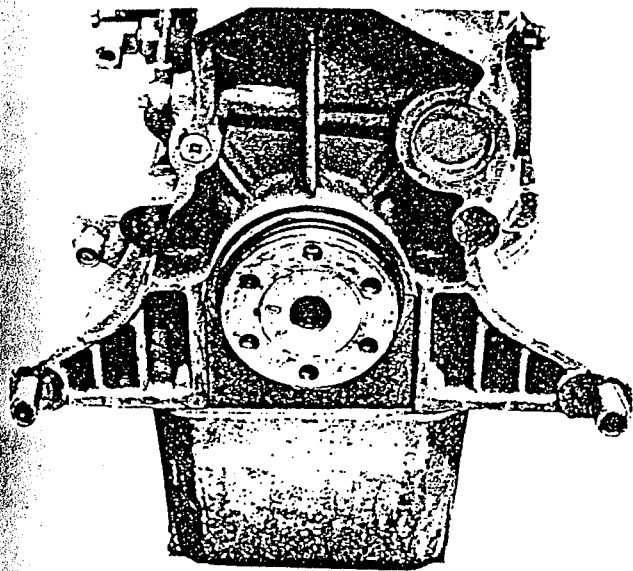

32. Unscrew the two bolts behind the gear wheel on the camshaft. Pull out the shaft together with the gear wheel.

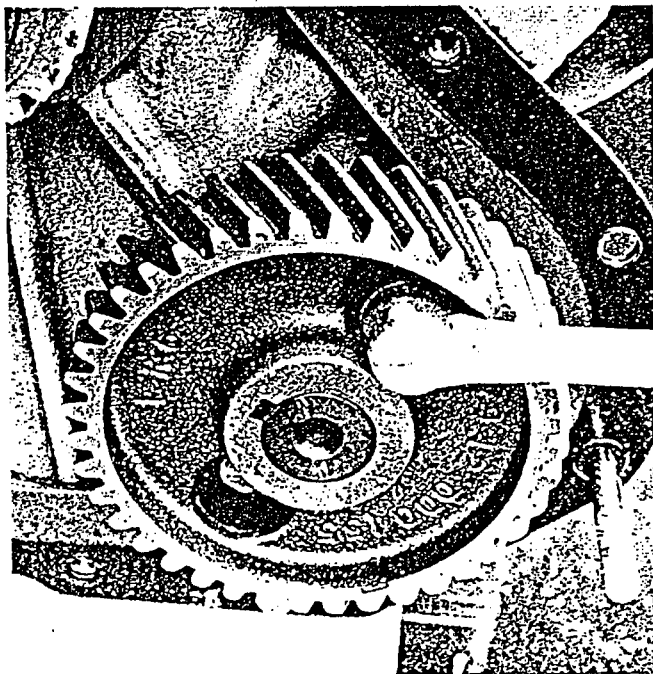

30. Remove the thrust washer for the oil pump. Take care of any shims. Invert the engine. NOTE. Protect the cylinder head face. Remove the sump. Scrap the gasket. Clean the contact surface for the gasket.

31. Remove the oil pump by undoing the cap nut on the port side of the engine. Then screw out the internal hex bolt. Pull up the pump.

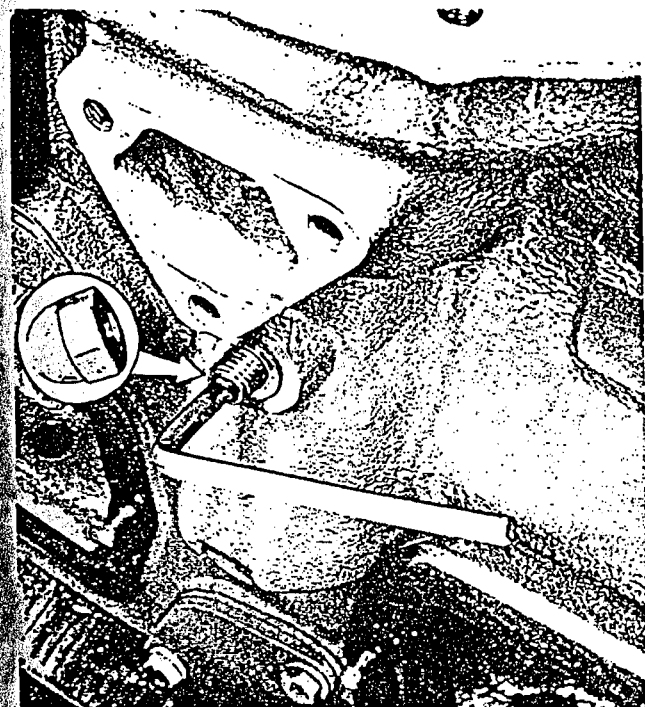

33. Unscrew the bolts for the inner timing gear casing. NOTE. The slotted screw is locked with punch pops which must be knocked up. Then pull out the casing from its guide pins.

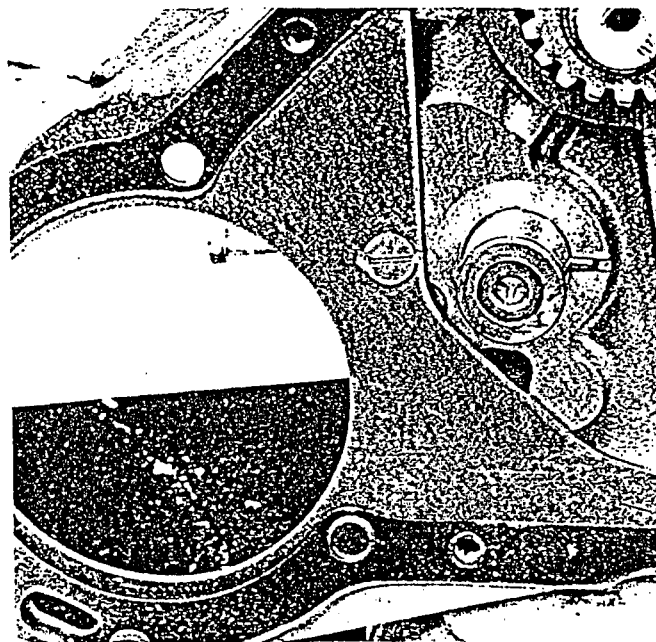

...oving connecting rods, crankshaft, liners

Release the nuts for the connecting rods. Mark the connecting rods with figures or points to ensure that they re-fitted in the same place after reconditioning. Carefully tap out the pistons.

36. Turn the engine block to the proper position and screw tight the liners with the special bolts. Use special tool, part No. 884382. Measure the liner height above the top surface of the block. The height should be between 0.025-0.09 mm (0.0010-0.0035").

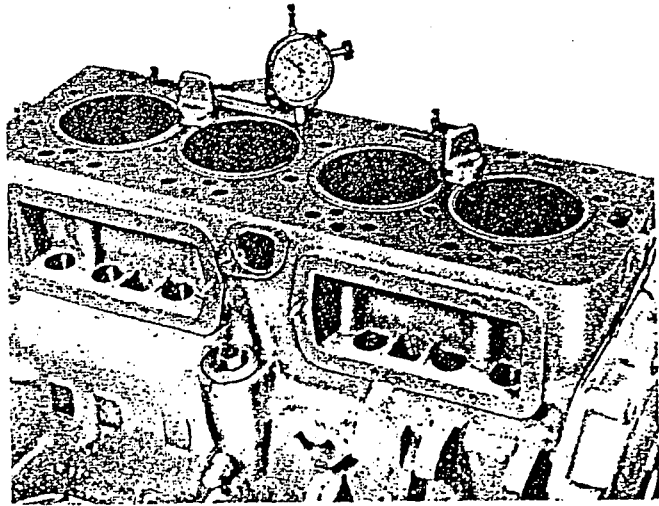
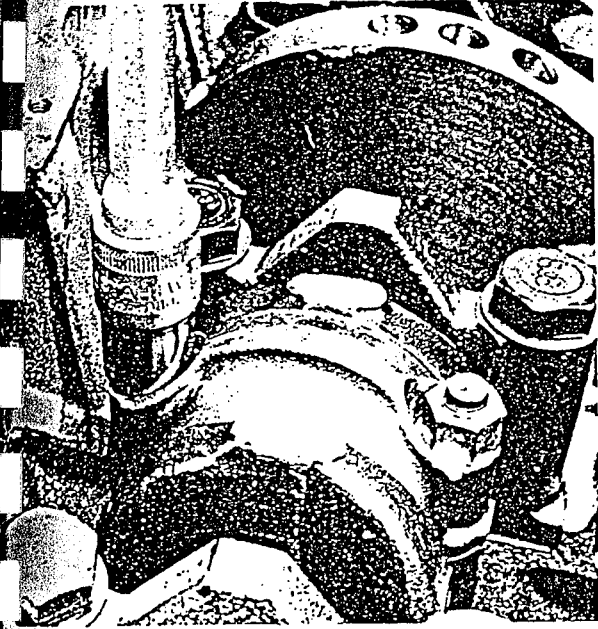

... Release the nuts for the main bearing caps. Remove the caps. Lift up the shaft.

Make sure that the caps are re-fitted in the same place where removed.

37. If the liners are too low or if there are faults and abnormal wear, remove the liners with tool 884231 and scrap them. Clean round the engine block and other parts which will be used again.

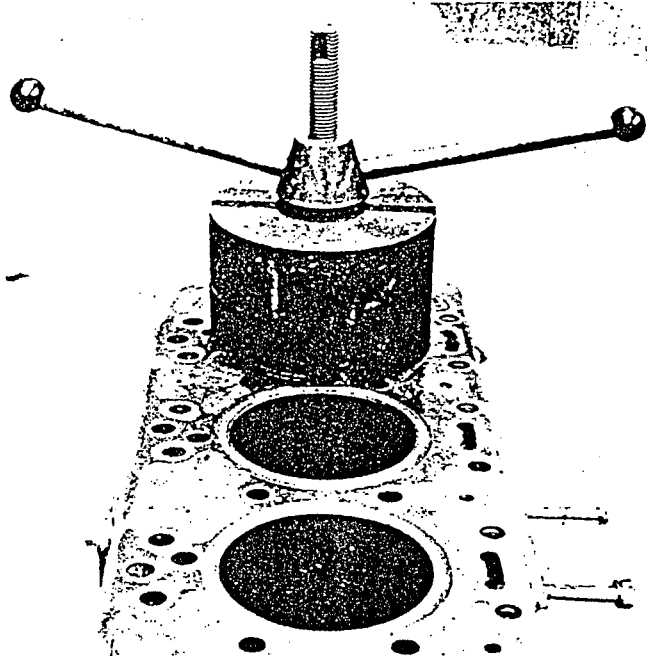
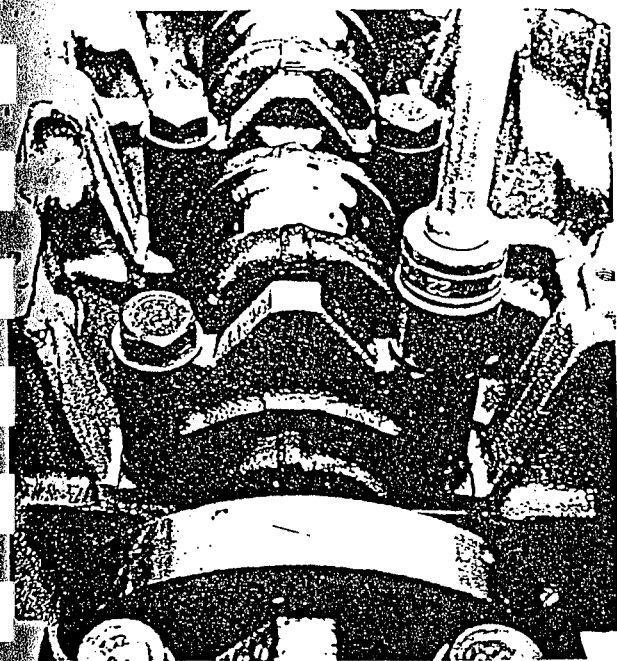

# Fitting

## Crankshaft

38. Invert the engine. NOTE. Protect the cylinder head face. Shape and fit the graphite packing with your hands. Then tap the packing down into its slot with tool 884235. Cut off the projecting part. Then carefully cut the gasket flush with the contact surface.

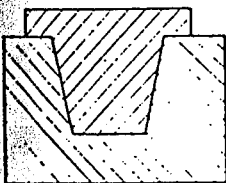
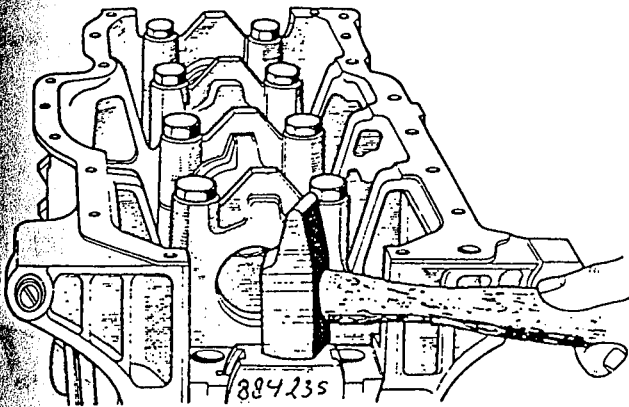

Wrong

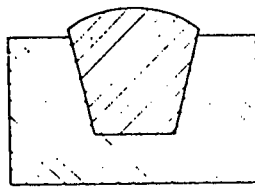

Right

39. Fit the bearing shells with oil grooves. NOTE. The hole in the bearing shell must coincide with the hole in the bearing seat. Oil the bearings. Fit the crankshaft.

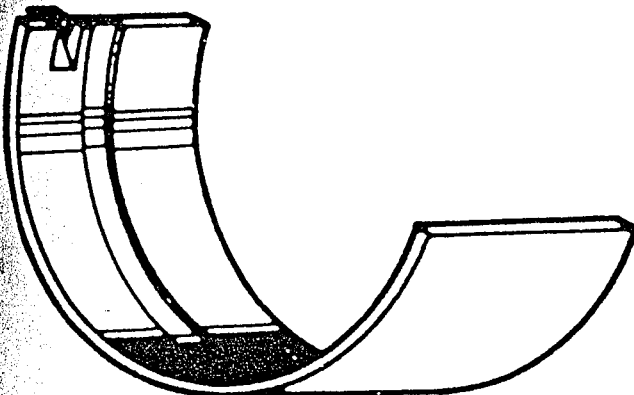

## Fitting the crankshaft

40. Fit an axial bearing on each side of the intermediate main bearing with the oil grooves facing outwards.

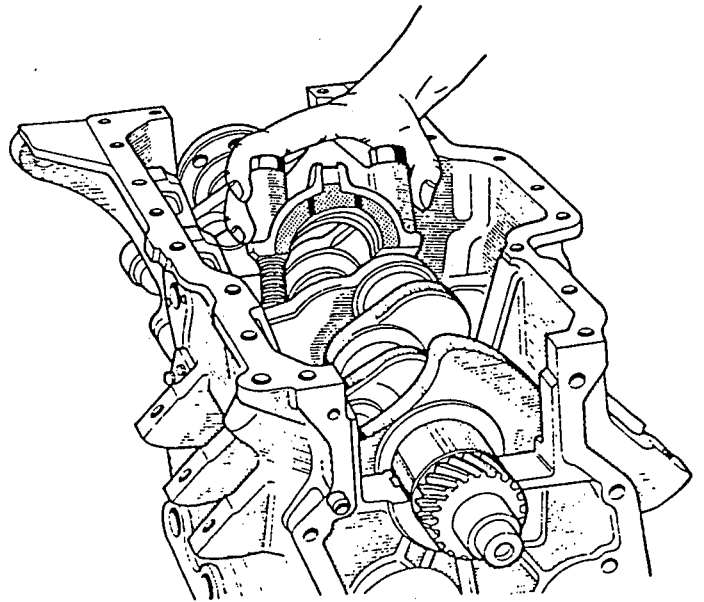

41. Oil the bearing halves. Fit the caps with the bearing halves. Check the marking on the caps to ensure that they are re-fitted in the same place as before removal. Turn the marking to face the injection side. Fit the side seals on the rear cap. The projecting part of the seal is cut off 0.5 mm (0.02") above the contact surface. Use a feeler gauge.

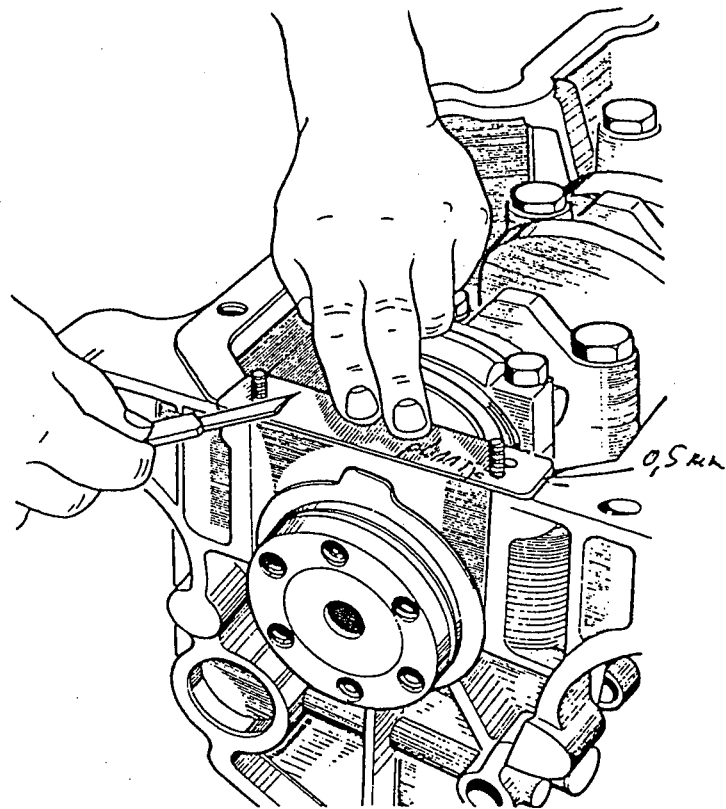

2. Tighten the bolts in stages with a torque wrench to 100 Nm (10 kpm = 72 lb.ft.). Oil the bolts before tightening them. Turn over the crankshaft. Check to make sure the crankshaft rotates easily without jamming.

#### Cylinder liners

43. If necessary, fit new cylinder liners without seals. Lock the liners with lock bolts 884382.

*0.03-0.09*

Check that the edge of the liner is  $0.025-0.09$  mm ( $0.0010-0.0035$ "') above the cylinder block. Use a dial indicator. Pull out the liners and fit new rubber seals. Make

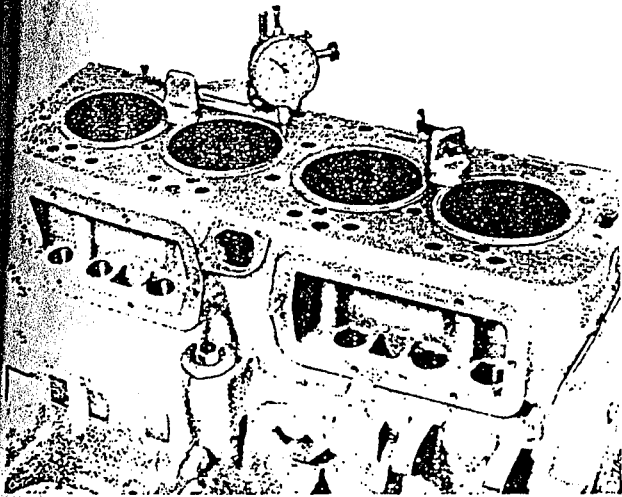

sure the seals are fitted properly. Turn the marking on the liners (1 or 2 grooves) to face the injection side.

#### Cylinder liner kits

Where a piston or cylinder liner must be replaced, this should be done as complete unit (this applies to the C and X marked kits), since the piston, cylinder liner and seal are matched together.

NOTE. A late prod. type cylinder head gasket must absolutely be fitted when replacing a cylinder liner. The gasket is included in the cylinder liner kit for a whole engine, but not in the cylinder liner kit per cylinder, where the gasket must be ordered separately. NOTE. The cylinder head gasket must be replaced even when only changing one cylinder liner kit.

#### Pistons

44. When replacing a piston, the piston bolt can easily be removed if the piston is first heated to about  $80^{\circ}\text{C}$  ( $176^{\circ}\text{F}$ ). Scrap the bolts and nuts on the connecting rods. Knock out the old bolts. Tap in the new ones with a hammer and drift. Fix the connecting rod in a vice with protective jaws.

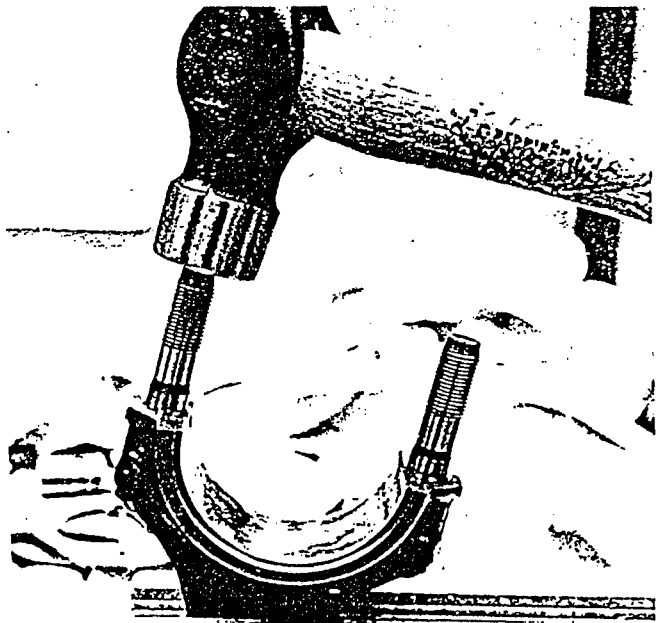

45. Fitting new pistons. Insert a circlip (4). Heat the piston to about  $80^{\circ}\text{C}$  ( $176^{\circ}\text{F}$ ). Fit the connecting rod so that its figure marking (1) faces the piston's "clover leaf" (2). Press in the piston bolt (3) and fit the other circlip. Then fit the bearing halves on the connecting rod and cap. Check that the bearing halves are fitted properly. Oil the piston and bearing surfaces.

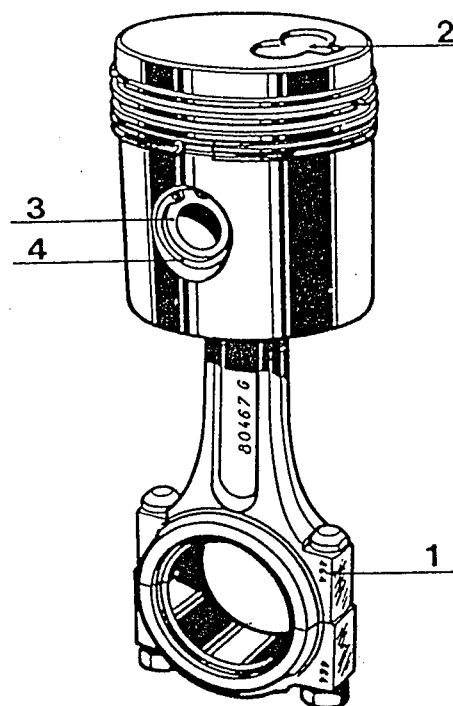



## Piston rings

46. Fit the piston rings with the help of piston ring pliers. Start with the oil scraper ring in the bottom groove. Thereafter fit the two similar rings which are marked "TOP" on one side. This marking must face up when fitting. Fit the top ring, which is chromium-plated. Turn the rings so that their gaps are displaced in relation to each other. NOTE. Monopol piston rings are neither marked with

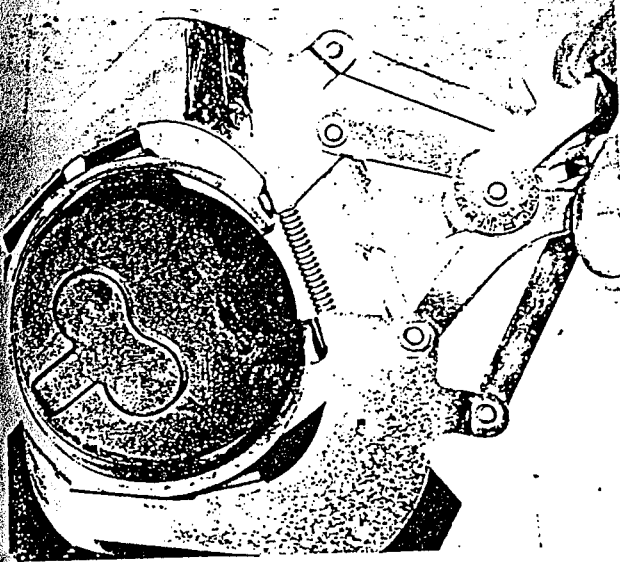

letters nor figures. On the other hand, these rings have a bevel on the inner diameter which must face up when fitting the rings.

47. Place the tool 884234 on the block (see picture). Oil pistons and tool well. The clover leaf marking on the piston crown should face towards the injection side during the fitting. Squeeze the rings in the tools and at the same time carefully tap the piston downwards with a wooden handle or similar. Fit according to the marks made on removal. Start with the pistons that are at top dead center. Then place the engine on its side and fit the bearing halves on those pistons that are installed. Thereafter turn the crankshaft until the next piston is at top dead center. Fit the piston and bearing half. Tighten the nuts with a torque wrench. Tightening torque = 60 Nm (6 kpm = 43 lb.ft.).

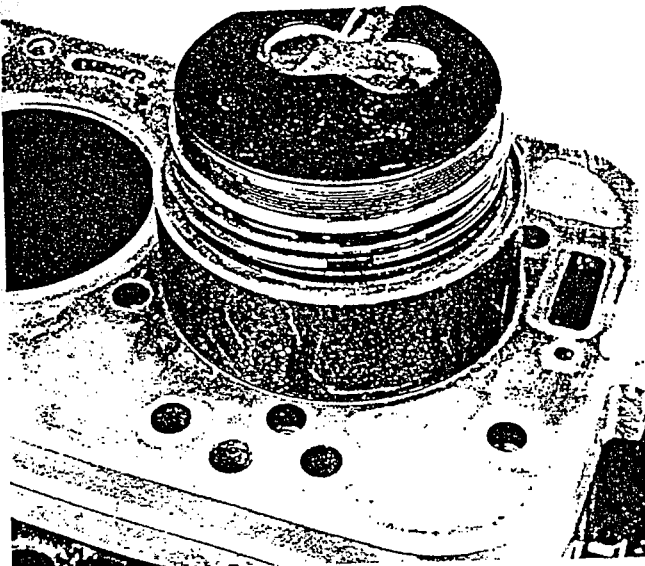

48. With the crankshaft, connecting rods and pistons fitted and the bearing cap bolts and connecting rod nuts tightened according to the prescribed torques, check to make sure that the torque for turning over the crankshaft does not exceed 60 Nm (6 kpm = 43 lb.ft.).

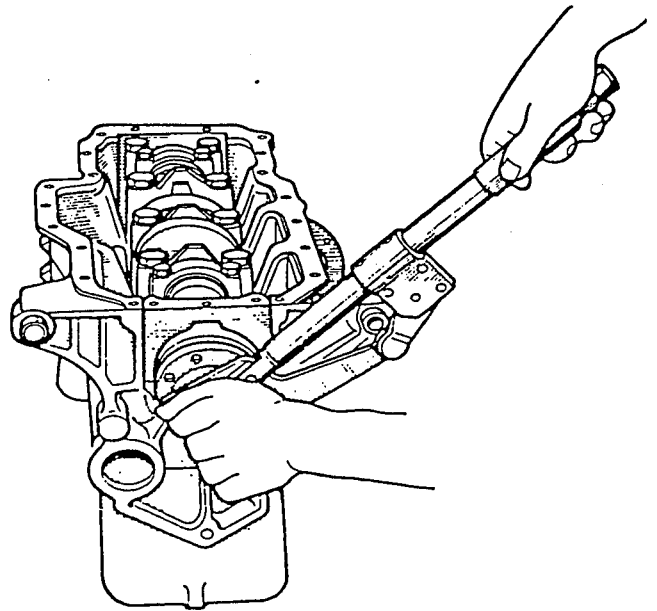

49. Check the camshaft cam and bearing positions. Lubricate and fit the camshaft. When replacing only the gear wheel, unscrew the two bolts behind the gear wheel and then draw the camshaft forwards so that one of the claw pullers can be placed behind the gear. When fitting the new gear wheel, it should first be heated to 80°C (176° F). Tighten up the two bolts holding the camshaft.

50. Fit the inner timing gear casing. Use new gaskets. Grease the contact surface. At the same time tighten securely the attachment for the alternator bolts. Lock the slotted screw with punch pops. The location of the casing is determined by the two guide pins.

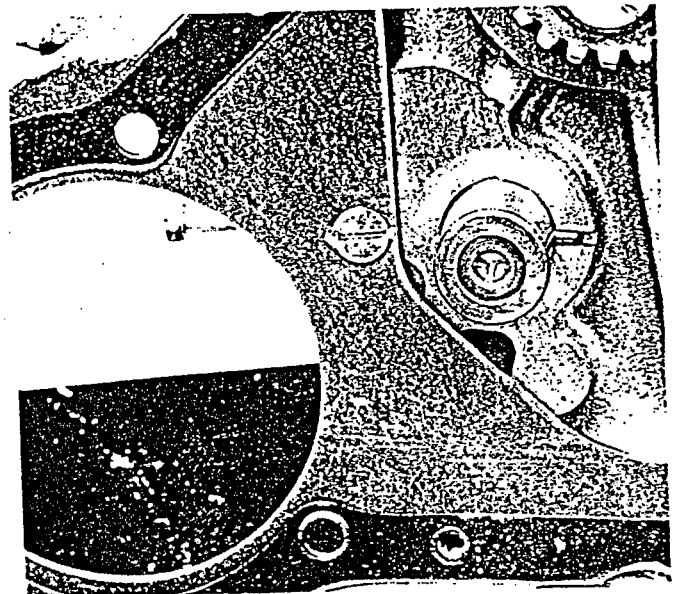

### Lubricating oil pump, crankshaft drive

The lubricating oil pump is of the gear type and should have an axial clearance (gear wheel) of between 0.02–0.06 mm (0.0008–0.0024") and backlash of between 0.15–0.25 mm (0.006–0.010"). Check the pump housing for wear, scoring and leakage. Worn or damaged parts are to be replaced. Also if the housing is so badly worn, the entire pump should be replaced.

Turn the pump in its proper direction and fit it to the cylinder block. Fit the stop bolt and tighten up the locknut. Do not forget the copper washer. Tighten the

the correct level so that the washer is exposed to light pressure from the spring. Fit the pipe so that the edge of the washer is 119 mm (4.7") from the contact surface of the oil sump on the MD21 and 155 mm (6.1") on the

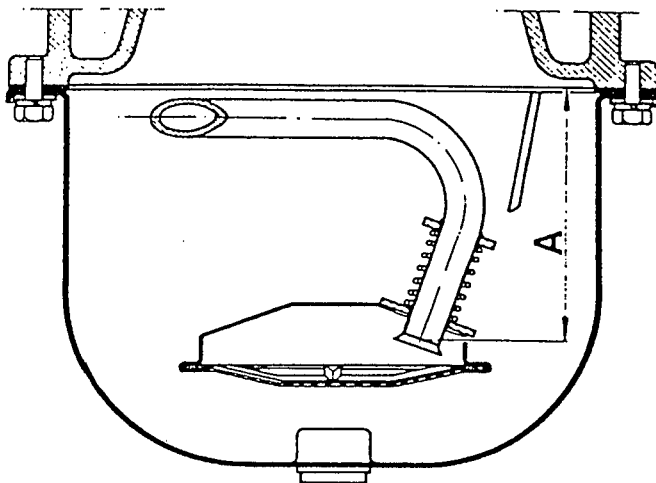

MD32. Check to make sure that the end of the suction line reaches into the strainer at least 10 mm (0.4").

53. Thoroughly clean the strainer in the sump. Release the screws securing the strainer. Wash with paraffin or similar. Screw tight the strainer when the sump has been cleaned.

54. Apply Permatex or corresponding to the edge of the block and the sump. Fit the new gasket on the block and fit on the sump. Tighten the bolts properly. NOTE. The holes at the front edge of the engine are through-holes so that bolts, washers and nuts must be used.

55. Fit the key and gear drive on the crankshaft.

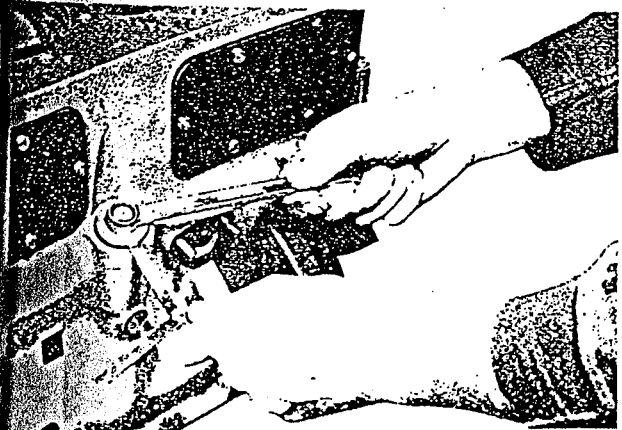

pressure plug lightly without shims. Measure the distance between the pressure plug and the block with the help of a feeler gauge. (See Fig.)

52. Fit shims under the pressure plug with a thickness corresponding to the measured clearance plus 0.05–0.10 mm (0.002–0.004") in order to obtain the correct clearance between pump and pressure plug. Shims are available in the following thicknesses: 0.1–0.2–0.5 and 1.0 mm (0.004–0.008–0.020 and 0.040"). Place the suction pipe at

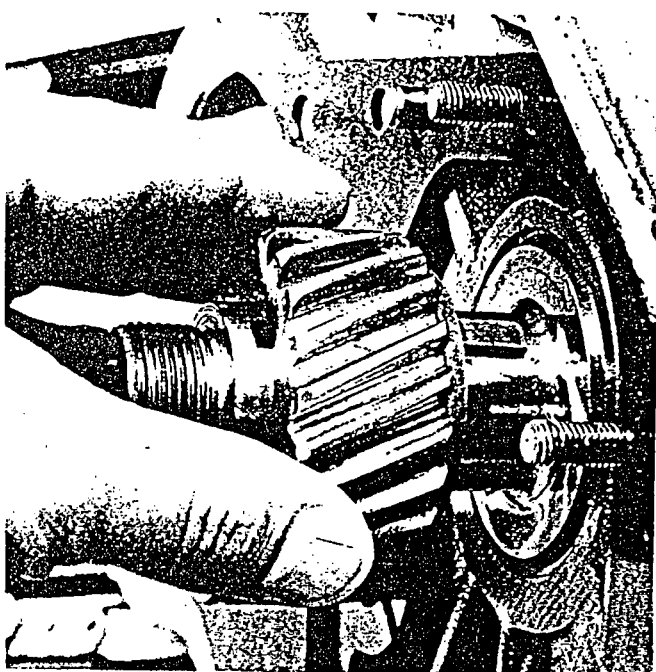
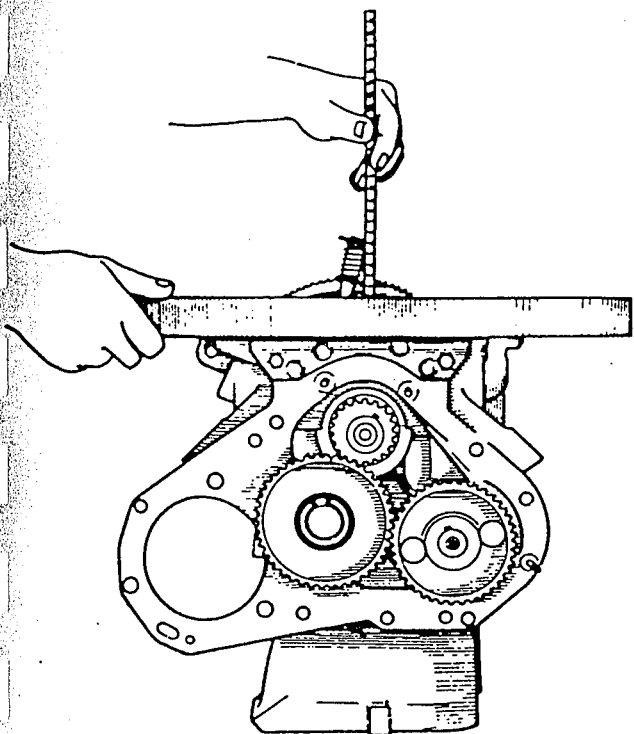

56. Fit the idler gear. Check that the line-up marking coincides with the marking on each gear and tooth opening. See Fig. below. Feel to see whether the gear wheels are stiff. There should be a certain backlash. Fit 1 mm (0.4") spacer washers on the idler gear shaft and fit the circlip. There should be an axial clearance of between 0.10–0.15 mm (0.004–0.006"). If the clearance is excessive, carefully knock in the shaft. Place a feeler gauge leaf between circlip and spacer washer.

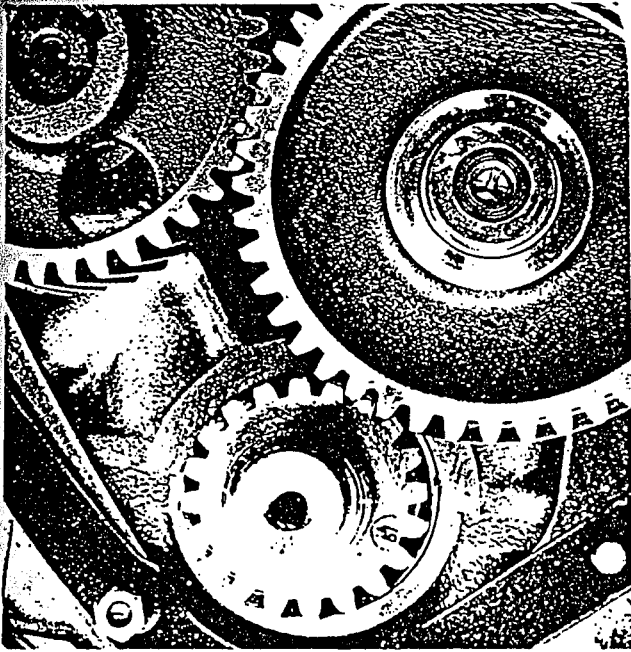

58. Check the front vibration damper (pulley) for any damage to the sealing surface. Engines with an engine number higher than 424673 (MD32) have a new type of vibration damper marked with a V. On changing the vibration damper, the new type should be fitted. Place the key in the slot on the crankshaft and fit the pulley carefully so that the sealing ring on the timing gear casing is not damaged. Apply Loctite to the threads and screw on the nut. Tighten up with a torque wrench (for the MD32) to a torque of 210 Nm (21 kpm = 152 lb.ft.). On the MD21 a lock washer and nut are used. The tightening torque for tightening the nut on the MD21 should be 170 Nm (17 kpm = 123 lb.ft.).

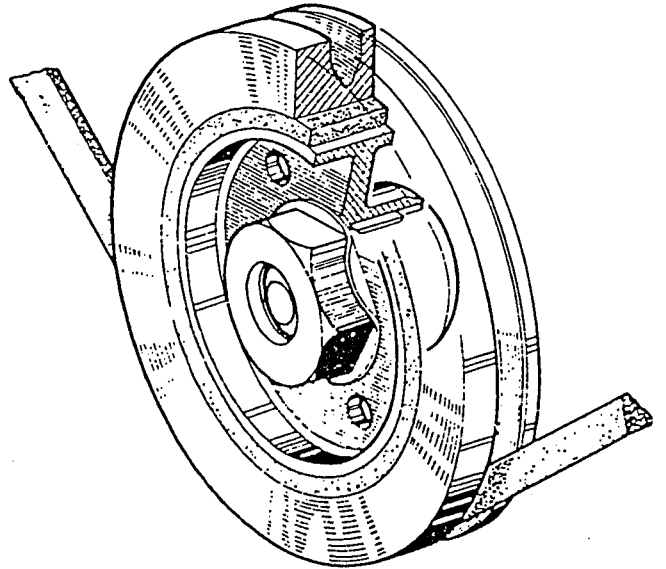

#### Cylinder head

59. Remove the valve springs with the help of a valve remover and take off all valve spring retaining locks. Remove the inner and outer valve springs. Place them on a rack in their proper order to ensure correct re-fitting.

57. Remove the sealing ring (1) on the timing gear casing and fit a new ring. Turn the sealing lip to face inwards towards the casing. Apply grease to the inner timing gear casing. Tighten up the two bolts in the casing before fitting on the gasket. Grease the other side of the gasket. Use a new gasket. Fit the outer timing gear casing.

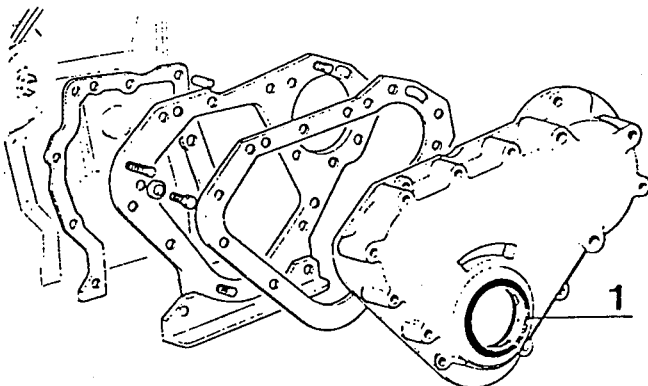

60. Remove the valves. NOTE. Place the valves on a rack in the order of removal. Burnt valves are to be scrapped if wear is excessive and damaged seats are to be milled or replaced if necessary (see "Technical Data"). Seat and valve should be ground together to ensure that the contact surface are absolutely tight and do not leak. (See Fig. 60.)

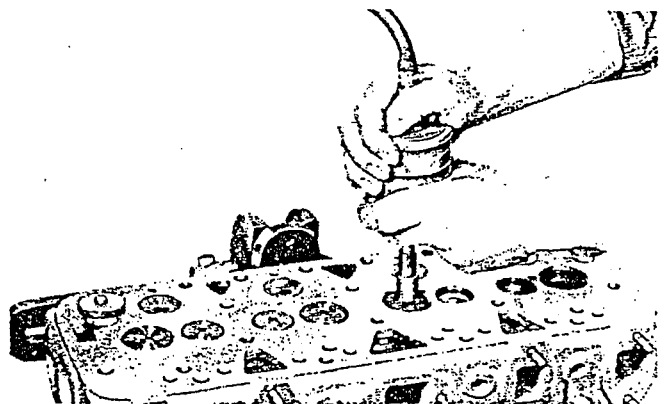

61. Guide  
Meas. in mm (in.)

| 61. Guide                     | Mark.  | Outer diam.   | Ream to  |
|-------------------------------|--------|---|--|
| 1st oversize                  | WHITE  | 14.13 (0.556) $\begin{matrix} -0 \\ -0.011 (0.0004) \end{matrix}$ | 14 (0.55) $\begin{matrix} +0.025 (0.0010) \\ +0 \end{matrix}$    |
| 2nd oversize                  | YELLOW | 14.29 (0.563) $\begin{matrix} -0 \\ -0.011 (0.0004) \end{matrix}$ | 14.2 (0.559) $\begin{matrix} +0.025 (0.0010) \\ +0 \end{matrix}$ |
| 3rd oversize                  | BLUE   | 14.59 (0.063) $\begin{matrix} -0 \\ -0.011 (0.0004) \end{matrix}$ | 14.5 (0.570) $\begin{matrix} +0.025 (0.0010) \\ +0 \end{matrix}$ |
| Inner diameter = 8.52 (0.335) |        | $\begin{matrix} +0.022 (0.0009) \\ +0 \end{matrix}$               |  |

Valves

Meas. in mm (in.)

| 63.                  | Intake valve  | Exhaust valve  |
|----------------------|---|--|
| Disc diam.: a        | 38.5 (1.52) D21<br>40.5 (1.60) D32  | 31.5 (1.24) D21<br>33.5 (1.32) D32   |
| Seat angle: $\alpha$ | 45°   | 45°  |
| Spindle diam.: b     | 8.52 (0.335) $\begin{matrix} -0.025 (0.0010) \\ -0.047 (0.0019) \end{matrix}$ | 8.5 (0.334) $\begin{matrix} -0.025 (0.0010) \\ -0.047 (0.0010) \end{matrix}$ |
| Length: c            | 116.25 (4.58)   | 116.25 (4.58)  |

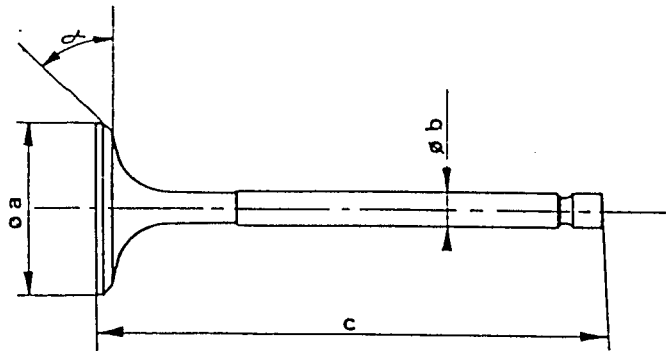
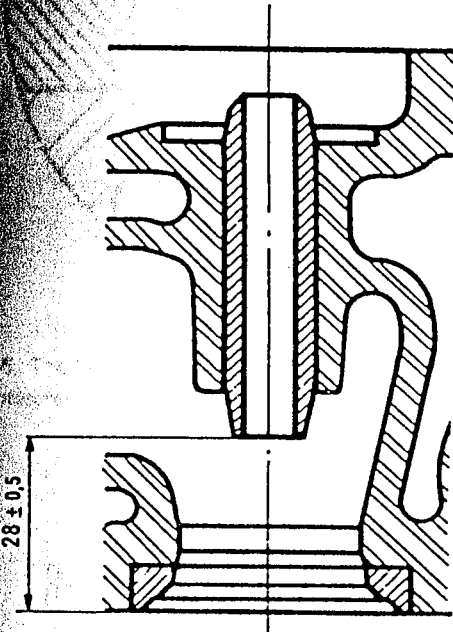

64. A B C  
WRONG RIGHT WRONG

The valve seat bevel angle should be 45°. The bevel should be between 2.2 and 2.5 mm (0.09 and 0.10") in width.

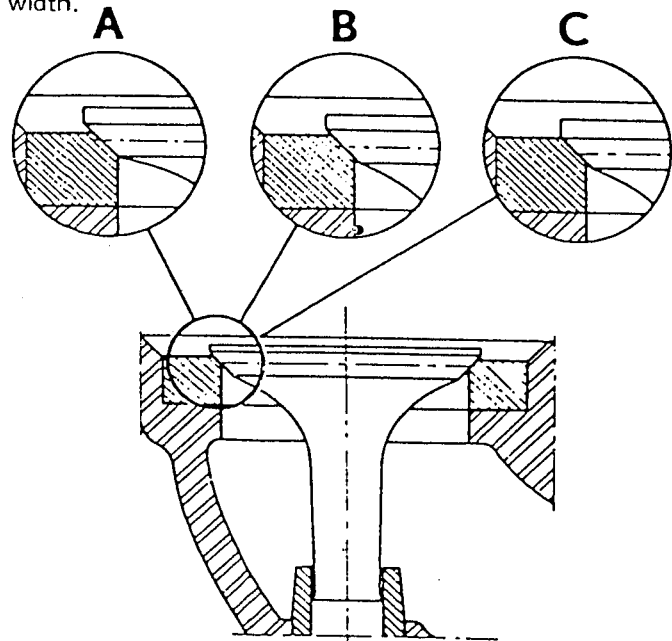

Valve springs

Meas. in mm (in.)

| 62.                      | Outer spring<br>R-H coil                  | Inner spring<br>L-H coil                    |
|--------------------------|---|---|
| MD21 length<br>with load | 24 ± 0.5 (0.94 ± 0.02)<br>37 kp (81 lb.)  | 20 ± 0.5 (0.80 ± 0.02)<br>15.5 kp (34 lb.)  |
| MD32 length<br>with load | 26 ± 0.5 (1.02 ± 0.02)<br>46 kp (101 lb.) | 22 ± 0.5 (0.87 ± 0.02)<br>45.8 kp (100 lb.) |

Replace damaged springs.

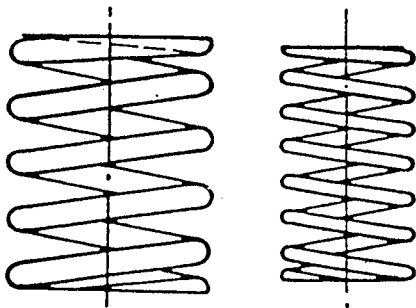

65. The measurement between the valve disc and the face of the cylinder head should be:  $1^{+0.15}_{-0.25}$  mm ( $0.04^{+0.006}_{-0.010}$ ”).

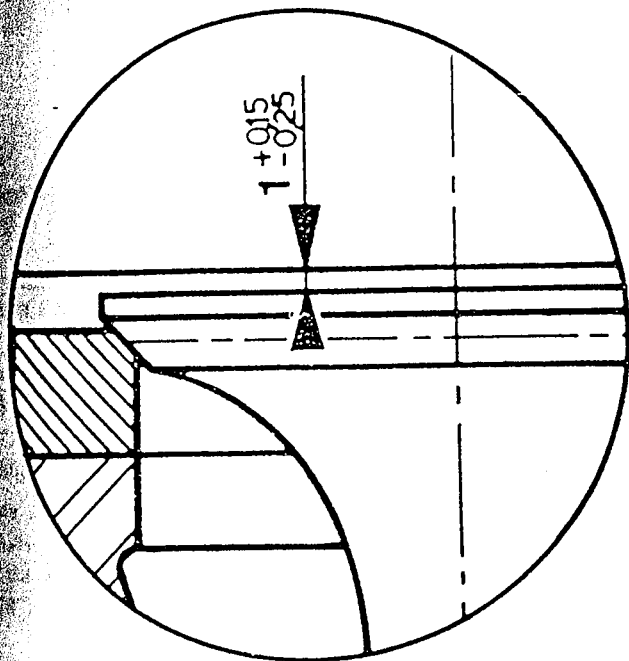

66. The bevel angle of the valve disc should be  $45^\circ$  and the measurement L should not exceed 3.3 mm (0.13”).

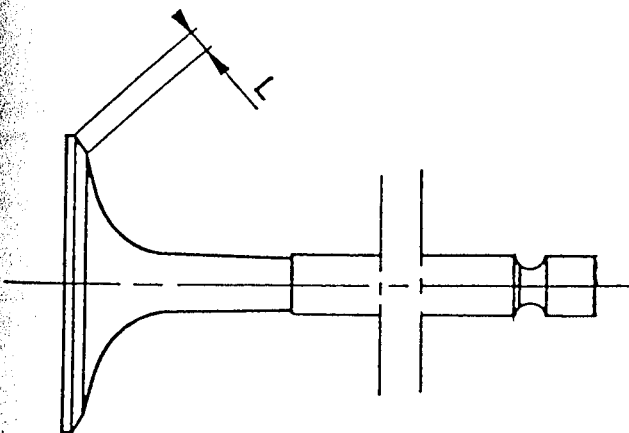

#### Cylinder head

67. The cylinder head is made of light-alloy. The original height measured from contact surface of the head to the face for the cylinder head bolts =  $90 \pm 0.015$  mm ( $3.54 \pm 0.0006$ ”).

NOTE. After the surface has been ground smooth, the height measurement A must not be less than 89.35 mm (3.52”).

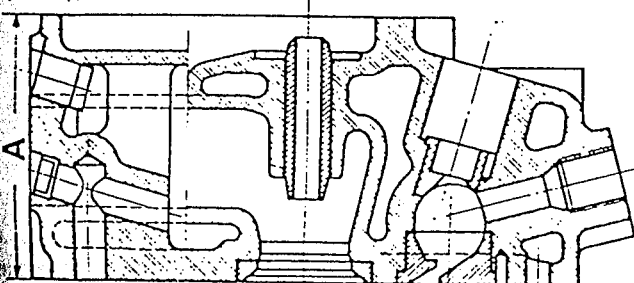

#### 68a. Checking the cylinder head face

With any such repair work where the state of the cylinder head surface is involved, check the face as follows:

After completely disassembling the cylinder head, clean it thoroughly. Measure with the help of a straight edge (check the edge on a flat surface). Place the straight edge on the cylinder head face as indicated by the arrows. Then measure with a feeler gauge the space between the straight edge and the cylinder head face at the measuring points.

A space of maximum 0.00–0.20 mm (0.00–0.008”) measured diagonally (crosswise on the face) and 0.00–0.10 mm (0.00–0.004”) measured laterally (transversely across the face) is approved. Grind the face if there is deviation of up to max. 0.50 mm (0.02”) from these measurements. If

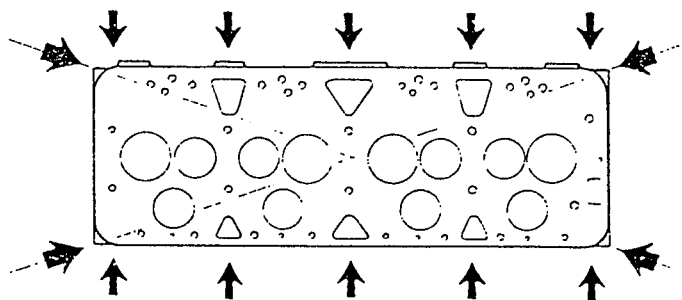

the measured exceeds 0.50 mm (0.02”), the cylinder head must be replaced with a new one.

#### 68b. Procedure before face grinding

Before carrying any face grinding, remove the prechambers because they have harder metal than the cylinder head. The prechambers can be knocked out with the help of a 6 mm (1/4”) thick metal drift, which is inserted through the recesses for the injectors. As a rule, the guide pin “A” remains in position during removal. Should any pin

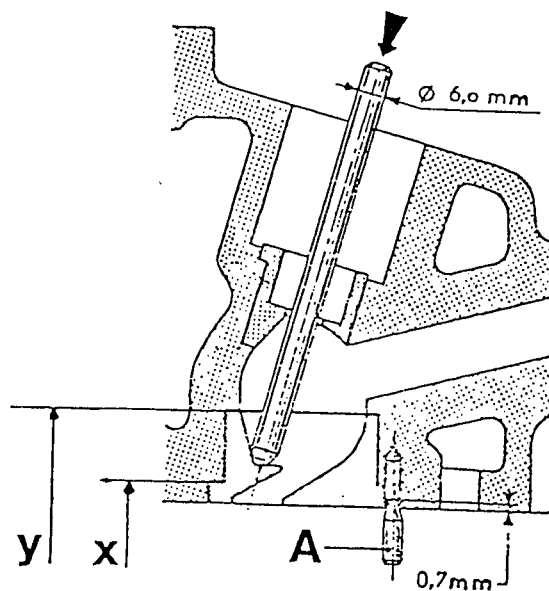

accompany the chamber when being removed, knock the pin down to 0.7 mm (0.028”) below the cylinder head face.

#### 68c. Procedure in connection with face grinding

In connection with face grinding, the prechambers should be lathed lower the same amount as the cylinder is ground.

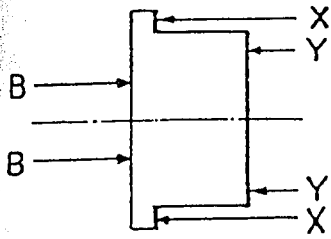

The lathing should be done on the prechamber's flat surface

**68 d. Fitting after face grinding**

Measure the depth to both the "X" and "Y" faces of the cavity for the prechambers (see Fig. 68 b), also the corresponding heights x and y of the prechambers (see Fig. 68 c). There should be a space of 0.1 to 0.5 mm (0.004 to 0.02") between the "Y" faces when a prechamber is at its bottom position, see Fig 68 d.

Rotate the prechambers in position for the guide pins and carefully tap the prechambers in until they bottom. Note that the guide pins should be knocked down to 0.7 mm (0.028") below the cylinder head face, see "A", Fig.2. If a

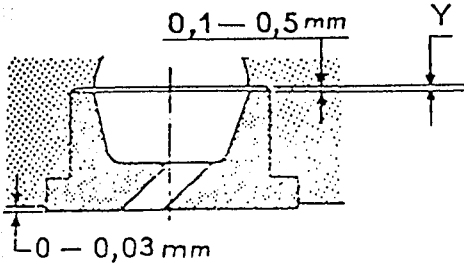

prechamber is stiff when fitting, shrink it by means of cooling. The face of the prechambers may not project outside the cylinder head face by more than max. 0.03 mm (0.0012"), see Fig 68 d.

**69.** Thoroughly clean the cylinder head, valve guides and valve seats. Use a small brush. See Fig. below. Check that the bevel on the seats is perfectly finished by coating marking

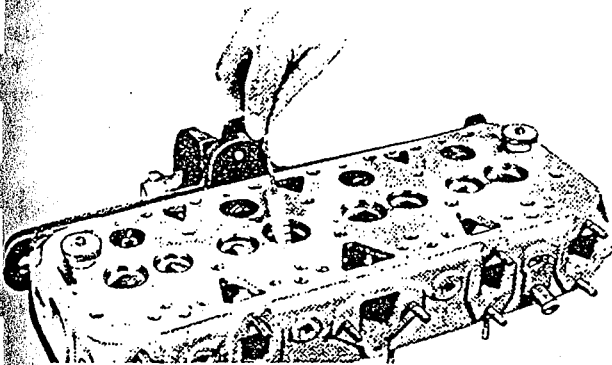

colour on the valve disc bevel and then by rotating it against its seat under light pressure. If marking colour spreads unevenly over the bevel surface of the whole of the seat (leaking valve), grind the valve again and make a new check until a satisfactory result is reached.

**70.** Oil the valve stems before fitting them in their respective guides. See Fig. NOTE: Make sure that the valves and valve springs are fitted in their original positions. Place

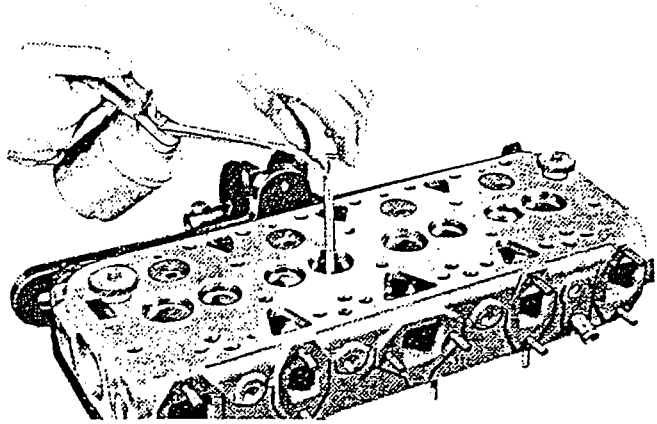

the cylinder head on its edge and fit the valve springs and the valve spring retaining locks.

**71.** Fit the dowels, 884384 (without stem) diagonally on the well-cleaned surface of the top side of the block. Fit on a new gasket. NOTE. If any liner has been replaced, a late prod. type gasket must be fitted.

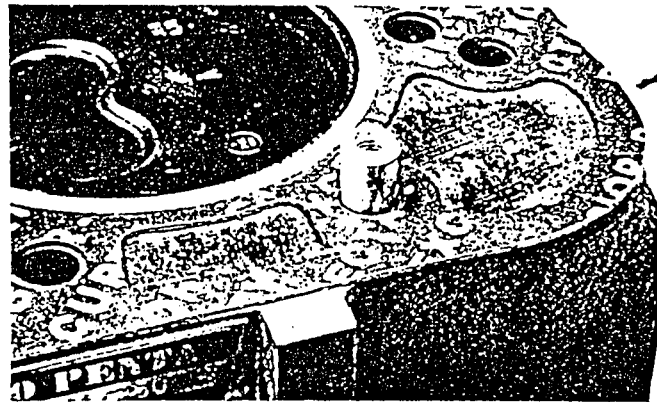

**72.** Clean the cylinder head surface and fit it on. Screw in the cylinder head bolts by hand. NOTE. The bolts have three different lengths.

Remove the two guide bolts with the help of the stem which has a left-hand thread. Then screw in the remaining two bolts.

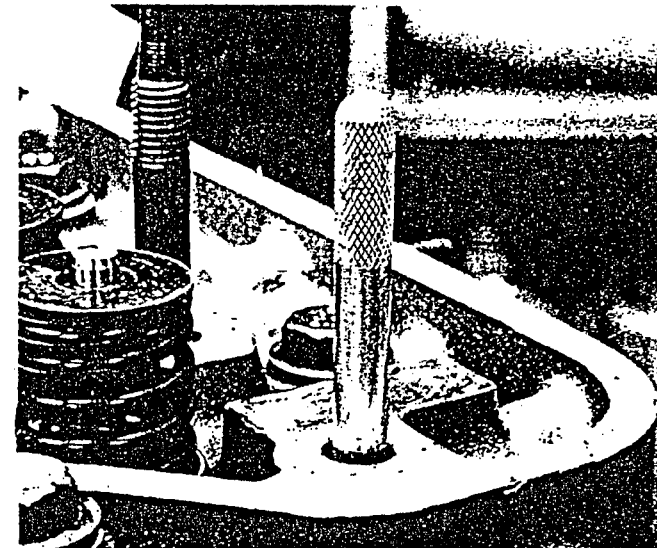

73. Tighten the bolts in the sequence shown in the Fig. below, that is, in two stages. First stage; to a torque of 35 Nm (3.5 kpm = 25 lb.ft.): second stage; to a torque of 70 Nm (7 kpm = 50 lb.ft.). See Fig. below. Use a torque wrench with special tool 884230.

The cylinder head bolts of a re-fitted cylinder head should be final-tightened after the engine has run for 20 hours. The engine should be cold when this is carried out. (Should have been stopped for at least 6 hours.) During launching each season, the cylinder head bolts should be check-tightened in the following way:

Mark the bolt head in relation to the cylinder head. Slacken the bolts 1/4 turn. Re-tighten all bolts with a torque wrench to a torque of 70 Nm (7 kpm = 50 lb.ft.). The marking on the bolt head should be opposite or past the marking on the cylinder head. With the same torque,

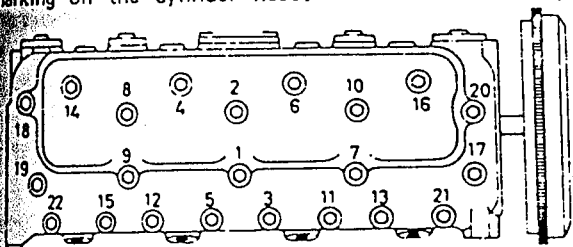

MD, AQD 21

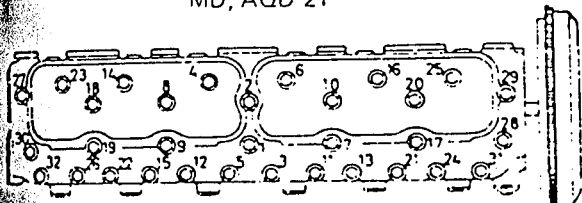

MD, AQD 32

tightening must be continued until the initial position is reached since any impurities in the bolt threads are probably preventing correct tightening.

74. Clean and oil the valve lifters and the seats for the valve lifters. Place the valve lifters in their original position and insert the push rods.

75. Fit the bracket. NOTE. The oil channel must be installed correctly from the beginning. Check that the gasket A is in good condition. On the AQD (MD)21 there should be a clearance of 0.1 mm (0.04") between the outer rocker arms and the support brackets.

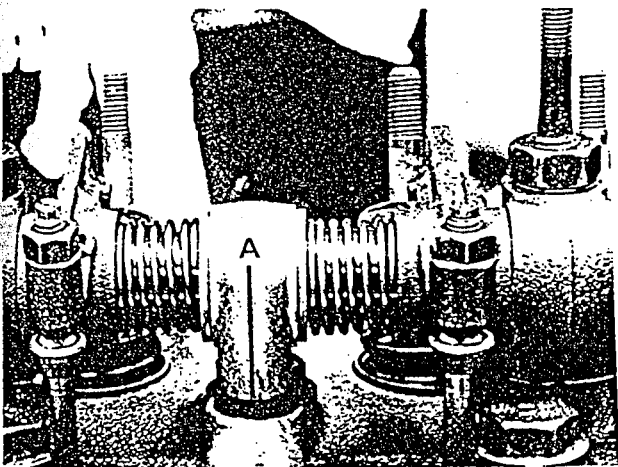

76. The engine must be cold when adjusting the valves, that is, it should have been stopped for at least 6 hours. The valves must not be adjusted when the engine is running.

77. When an engine has been reconditioned, the cylinder head bolts should be final-tightened after the engine has run for 1 hour.

The cylinder head bolts should be tightened again after a further 20 hours of operation or if the engine has been stopped longer than 3 months. **IMPORTANT!** Final-tightening should be done when the engine is cold, which means at least 6 hours after it has stopped. After final-tightening the cylinder head bolts, adjust the valves. Turn over the engine so that the respective exhaust valve according to the table below fully opens. Then adjust the valves according to the table.

| Preadjustment of valves |           | Open valve fully |
|-------------------------|-----------|------------------|
| MD21                    | 13 and E4 | E1               |
|                         | 14 and E2 | E3               |
|                         | 12 and E1 | E4               |
|                         | 11 and E3 | E2               |
|                         |           |                  |

Valve clearance:

|                 |                    |                    |                       |
|-----------------|--------------------|--------------------|-----------------------|
|                 | Before first start | 1 hours' operation | 20 hours' op. or more |
| Inlet valves:   | 0.25 mm (0.010")   | 0.25 mm (0.010")   | 0.15 mm (0.006")      |
| Exhaust valves: | 0.35 mm (0.014")   | 0.35 mm (0.014")   | 0.25 mm (0.010")      |

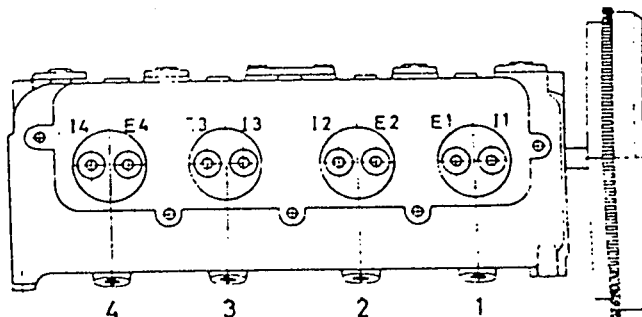

MD21, AQD21

| Preadjustment of valves |           | Open valve fully |
|-------------------------|-----------|------------------|
| MD32                    | 15 and E3 | E1               |
|                         | 13 and E6 | E5               |
|                         | 16 and E2 | E3               |
|                         | 12 and E4 | E6               |
|                         | 14 and E1 | E2               |
|                         | 11 and E5 | E4               |

Valve clearance:

|                 |                    |                    |                       |
|-----------------|--------------------|--------------------|-----------------------|
|                 | Before first start | 1 hours' operation | 20 hours' op. or more |
| Inlet valves:   | 0.25 mm (0.010")   | 0.25 mm (0.010")   | 0.15 mm (0.006")      |
| Exhaust valves: | 0.35 mm (0.014")   | 0.35 mm (0.014")   | 0.25 mm (0.010")      |

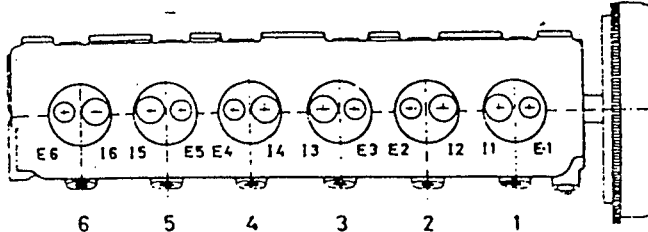

MD32, AQD32

**NOTE!** Do not take out full engine output before final-tightening at 20 hours' operating time.

the rocker casing groove with Permatex. Place the cover over the groove. Then place the cover over the rocker. Fit a plate washer and packing washer on each side. Tighten up the casing with the nuts.

the oil pressure pipe for the rocker mechanism. The pipe is clamped tight with one of the bolts on the rocker cover.

Inspection covers for the valve lifters. The inspection covers are different on the 32 and can only be fitted in

the 21 the covers are symmetrical. Apply Permatex to the contact surface of the covers and grease the engine's surface. Fit new gaskets on the covers and tighten them to the engine. NOTE. Tighten the bolts carefully. The exhaust pipe will later prevent any final-tightening event of leakage.

81. Release the nut on the bolting holding together the two halves of the housing. Release the bolt holding the cam. Remove the cam.

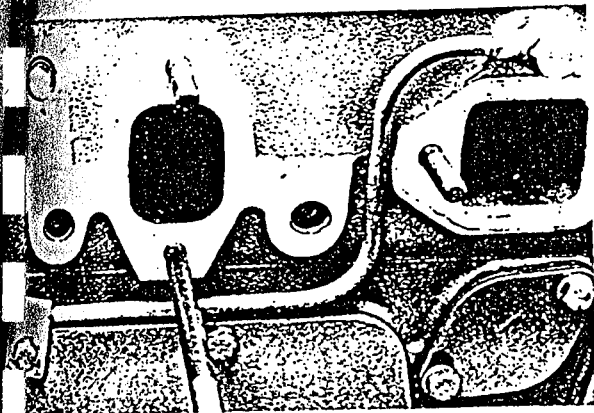
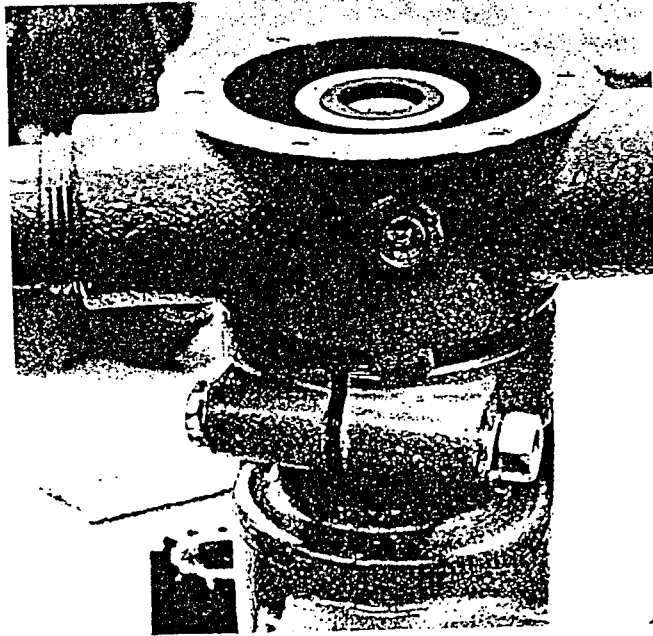

sea-water pump

Remove and recondition the sea-water pump. Take off the cover and press the impeller out of the pump housing with the help of a screwdriver. Observe due care not to damage the edges of the housing with the screwdriver. The impeller is fitted on splines and should be pulled straight

82. Open the circlip (the small one) with circlip pliers and pull out the shaft from one of the housing halves. Remove the brass wear washer. The rubber and carbon gaskets are then accessible for removal. Fit a new, complete set of gaskets.

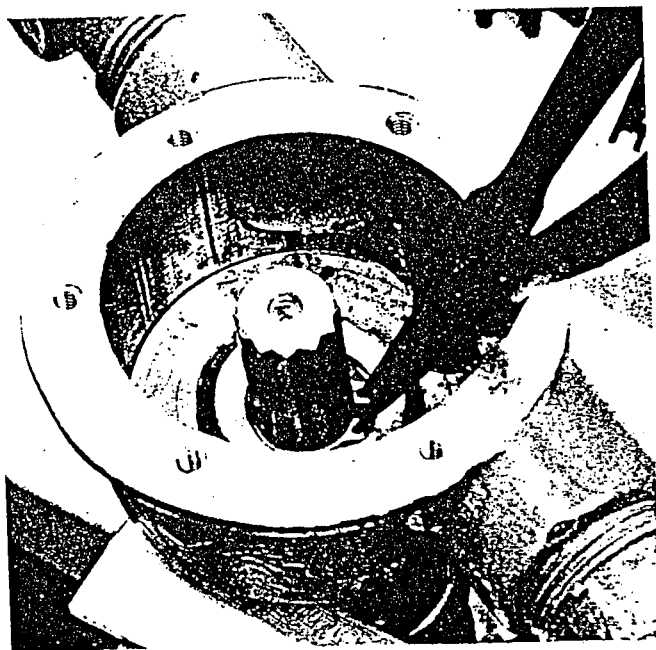
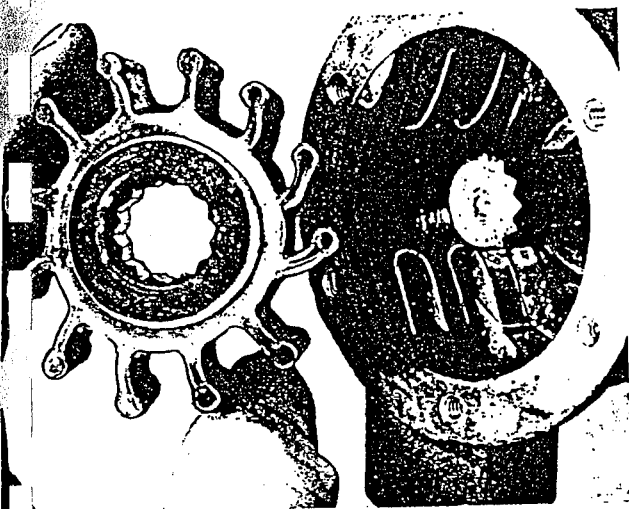



83. Remove the flange and bearing with the claw puller. The flange has a key. A spacer sleeve is situated on each side of the gear wheel which is fixed on the shaft. Clean and if necessary replace parts.

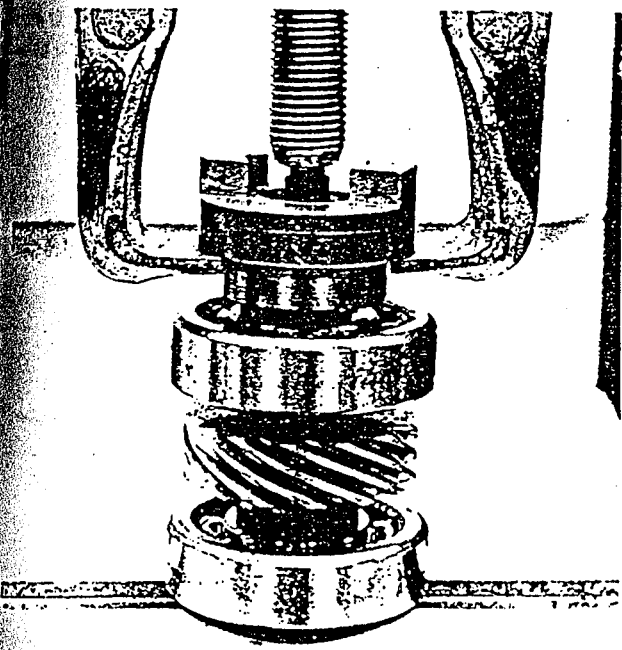

85. Fit the set of seals onto the "small" housing. Tighten up the bolting. Fit the circlip onto the shaft. Place the wear washer on the shaft and fit the cam. Use Locktite or similar on the bolt and cam. Fit the impeller and then the seal (rubber plug) for the splines. Finally fit the cover together with the new gasket.

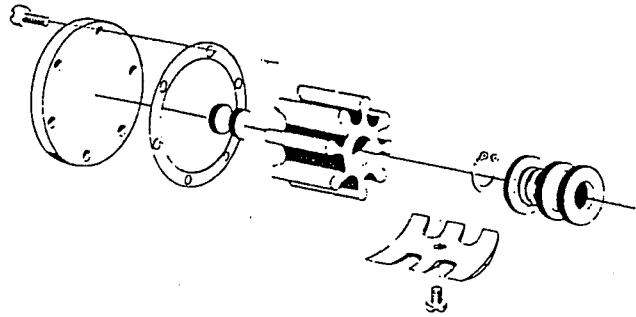

#### Fitting

84. Replace the shaft - gear wheel complete. Assemble the pump as follows:

Fit spacer sleeves on both sides of the gear wheel. Press on the ball bearings. Insert the key and fit the flange. Use a press.

Replace the sealing ring in the "large" housing. Press the shaft with bearing onto the housing. Fit the large circlip. Fit the "rubber washer" onto the shaft.

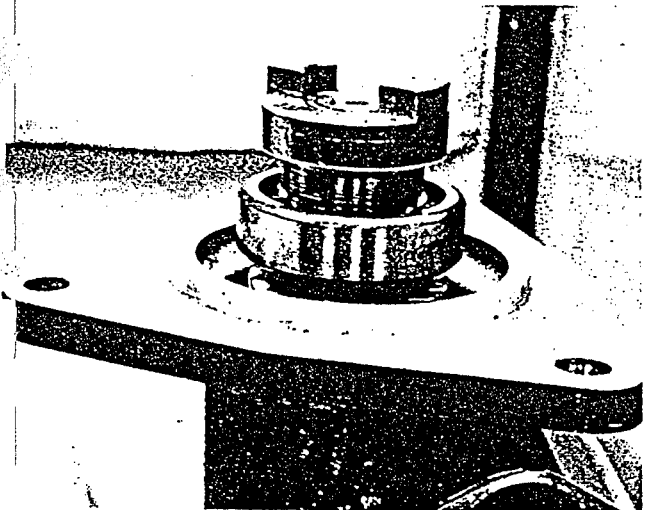

86. Fit the sea-water pump loose with gasket and bracket for the heat exchanger onto the timing gear casing. The pump is finally fitted together with the fuel injection pump.

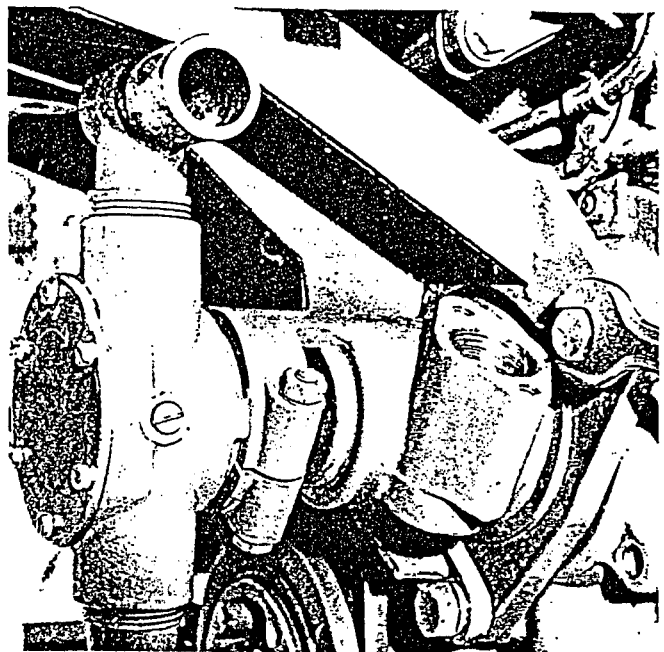

## Circulation pump

### Removing

87. Release the nut and pull off the pulley. Pull off the impeller with a puller (see Fig.) and take out the water pump seal. Remove the front bearing circlip and drive out forwards the shaft with bearing. Take out the other bearing from the pump housing. Scrap defective parts.

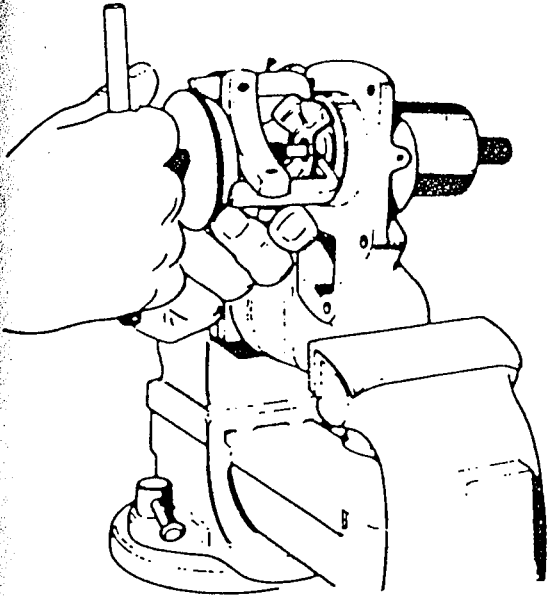

### Fitting

88. Grease the ball bearings and fit them onto the shaft with the open sides facing each other.

Press the shaft with bearing into the pump housing and fit the circlip. Tap on the shaft so that the space between shaft, bearing and circlip on the shaft disappears.

Place the water pump packing on the shaft and press on the impeller.

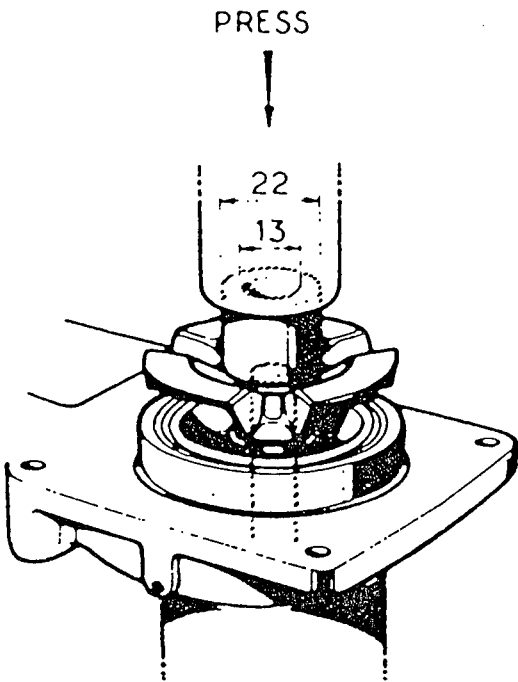

89. The impeller should rotate without sticking. The distance between the pump housing and impeller should be 0.45– 1mm (0.018–0.040"). Fit the pulley and tighten the nut to a torque of 35 Nm (3.5 kpm = 25 lb.ft.).

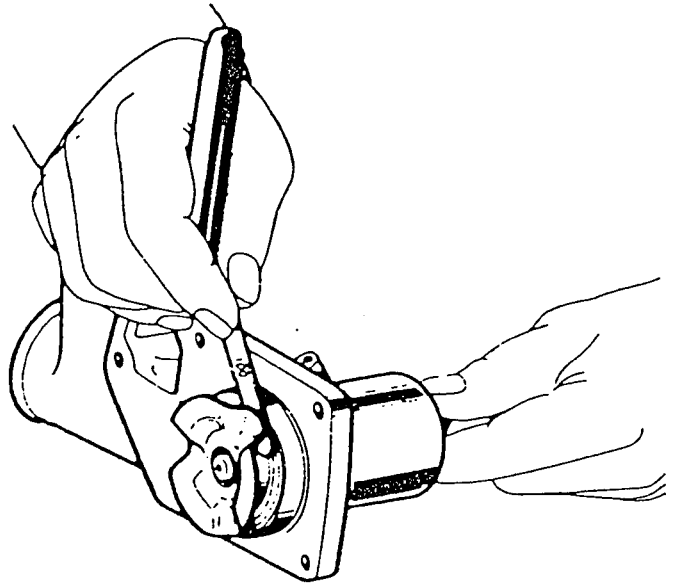

90. Apply Permatex to the surface of the fresh-water pump. Fit on a new gasket. Grease the block's contact surface. Fit the pump. Tighten up the bolts diagonally.

### Feed pump

91. Remove the cover on the pump and clean the strainer. Check to make sure that the pump is sucking. (A chattering sound is heard when the hand primer is pressed in.) Fit the strainer and cover and grease the mechanism. Fit the feed pin with a new O-ring and a fiber packing on each side of the large plate washer.

Fit the fuel pipes onto the feed pump before screwing the pump tight to the engine. Use new seals on the fuel pipes.

### Reconditioning the feed pump

92. If the pump does not suck, remove the rubber diaphragm as follows: Turn the diaphragm a bit to the one side so that the manual pump arm releases from the diaphragm recess, see Fig.

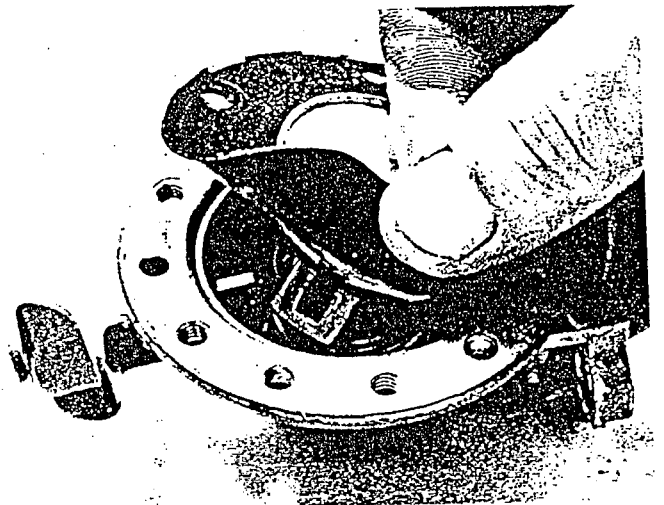

93. Press the diaphragm shaft obliquely towards the manual pump arm and turn up the whole diaphragm assembly with the finger tips, see Fig. The finger of the other hand can be used to press in the mechanical pump arm in order to facilitate removal. The new diaphragm is fitted exactly in reverse order, that is, obliquely downwards and turned into mesh with the pump arm. Fit the cover and check that the pump is functioning ("chatters").

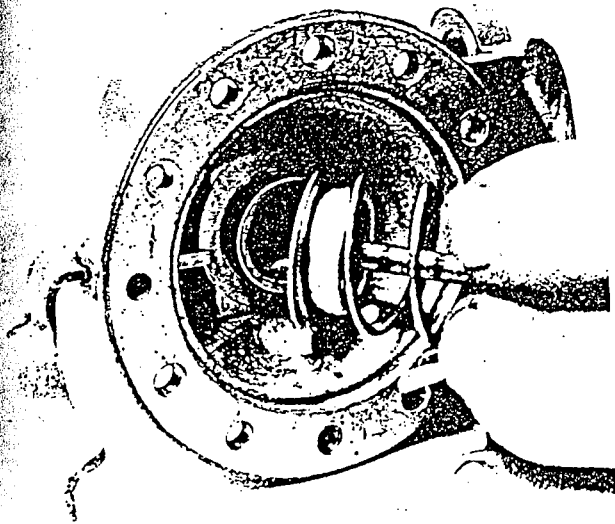

94. The two small covers on each side of the engine have gaskets which must be replaced if the engine has been washed, since the washing fluid may have ruined the old gaskets.

95. Fit the heat exchanger loosely onto the engine. NOTE. First fit on the small rubber hose with hose clamps. (Applies to MD32.) Replace the expansion cover (the old type) for the new one with hose and expansion container, if this has not been fitted previously.

96. Fit the gaskets for the exhaust manifold on the studs. Mount the exhaust manifold well with the nuts. NOTE. Nylock nuts should be used on the inside.

Fit the plate with the lift eyelet and gaskets between the exhaust manifold and heat exchanger. NOTE. On the MD21 the lift eyelet faces forwards as shown in the Fig., while on the MD32 it faces rearwards.

Fit the bracket for the fuel pipe on the lift plate. Grease the bolt with the lock wire and tighten it to the heat exchanger. Observe due care that the bolt is not at an angle. On late prod. units, the lift eyelet is screwed into the heat exchanger and the lift plate shortened at the "arrow" (Fig. below).

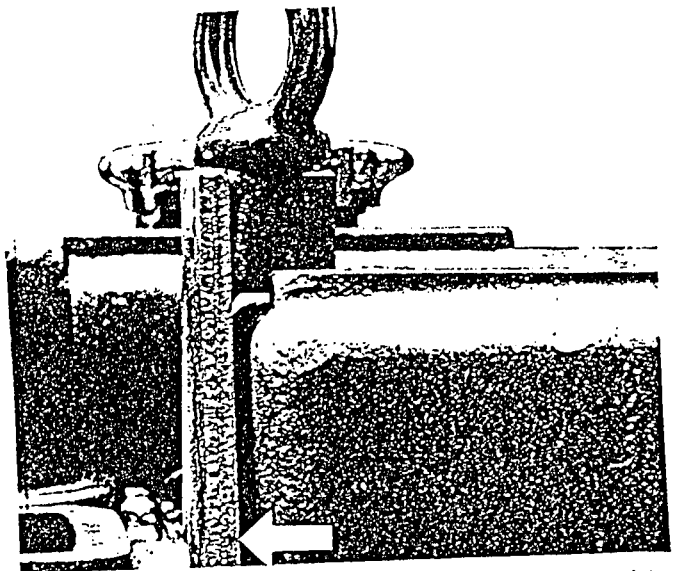

97. Lower the thermostat into warm water and test with a thermometer to see if the thermostat opens and closes at the right temperature, which is 68–72°C (154–162° F). The thermostat should be fully open at 83°C (181° F). If the thermostat is faulty, replace it. Fit a new packing on the thermostat housing. Tighten up the housing with the two stainless steel bolts (MD32). Stainless steel nuts and washers for the MD21. Fit the rubber hose between the sea-water pump and the heat exchanger. Tighten up the hose clamps. Fit the heat exchanger cover.

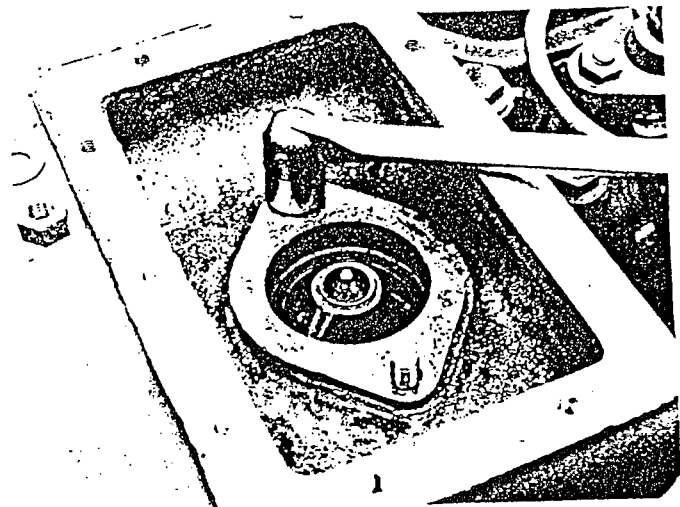

98. Check the bearing for the primary shaft. Replace it if damaged, also grease it before fitting. Fit O-rings and guide tubes for the inner flywheel casing. Fit on the casing and tighten it up. Apply Tecyl or similar rustproofing to the inside of the flywheel and screw it tight to a torque of 65 Nm (6.5 kpm = 47 lb.ft.). Tighten the bolts diagonally. NOTE: The tabs on the lock washer should be bent over the bolt heads. Also rustproof the front side before bolting on the vibration damper.

99. Fit the sealing ring on the flywheel casing. Check the primary shaft and bearing (applies to AQ version). Press the shaft into the flywheel casing. Fit the circlips. This applies if the shaft and bearing were removed. Before fitting the casing with gasket, rustproof the primary shaft well. Fit the lift eyelet on the casing as shown in the Fig.

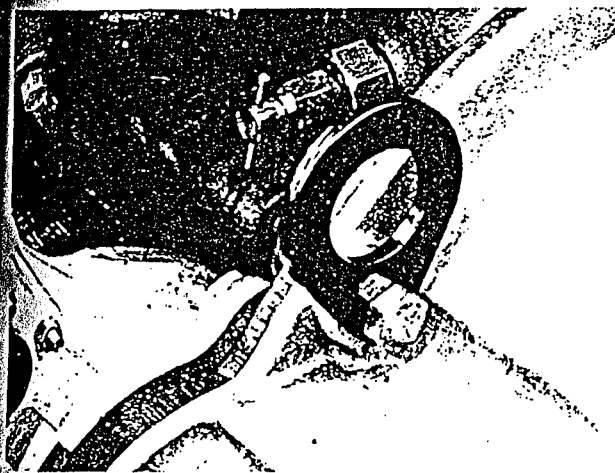

100. On the AQ versions, the drain cocks on the exhaust pipe should be at the front edge and should have an angle union in order to make it easier to get at them. The rear hole is plugged. On inboard engines, the drain cock is placed at the rear edge of the exhaust pipe and does not have an angle union. The front hole is plugged.

The Fig. shows the old type, which should be replaced by the new one during reconditioning.

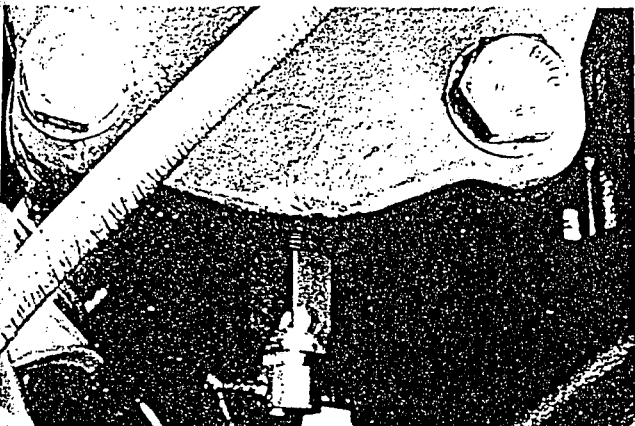

#### Adjustment of injection pump

101. Remove the valve cover. Turn the crankshaft until the exhaust valve on cylinder no 1 (nearest the flywheel) closes and the inlet valve opens. The rocker arm for cylinder no. 4 on the MD21 engine is pushed to one side and tool 884473 is placed on the valve. See figure. NOTE! Remove the outer rocker arm on the MD32. Place the tool on the valve afterwards. Remove the collets and the springs. The valve drops down on the cylinder approximately 2 mm.

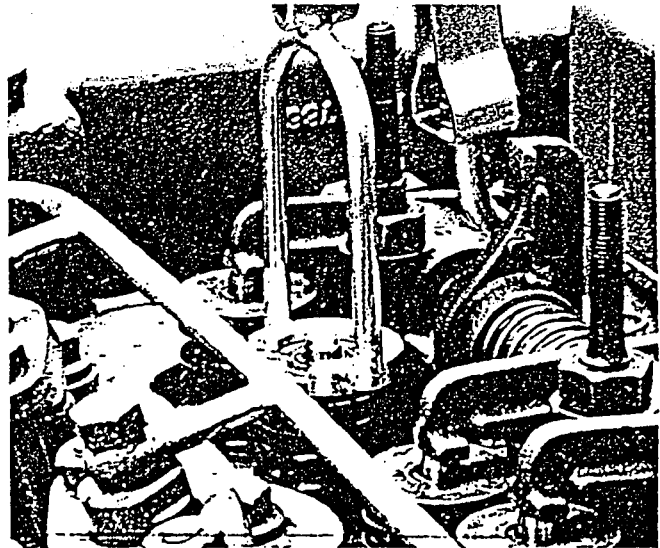

102. Fit the dial indicator on the valve and rotate the crankshaft until the valve reaches T.D.C. The marking No. 2 on the pulley should now coincide with the marking on the timing gear casing. Rotate the crankshaft anti-clockwise so that the piston goes down 3 mm (0.12"). Observe the dial indicator. Again rotate the crankshaft clockwise 0.96 mm (0.038") for correct adjustment on the MD32, see table under point 108. NOTE. The engine must be turned over clockwise to the indicated value in order to avoid having gear clearance in the measuring. The marking No. 1 on the pulley should now coincide with the marking on the timing gear casing. If the marking does not coincide, then the outer ring on the vibration damper has moved, but this does not require any action.

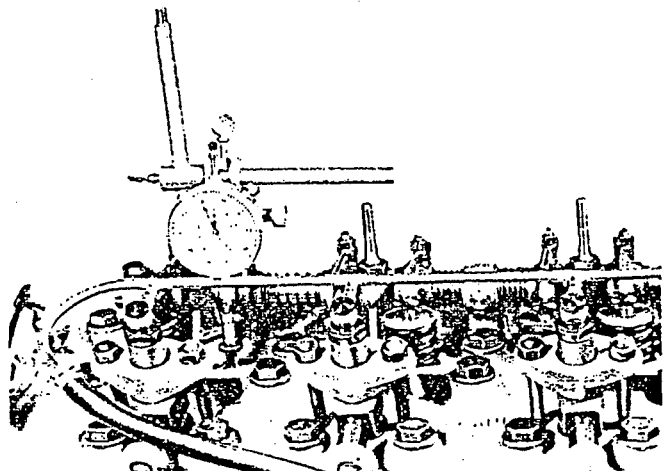

103. Adjusting the firing position for the MD22 is in the same way, apart from the fact that the crankshaft should be rotated anti-clockwise 4 mm (0.16") and then again clockwise 1.13 mm (0.04"). NOTE. The engine must be turned over clockwise to the indicated value in order to avoid including gear clearance in the measuring. The Fig. shows the pulley marking with advanced injection.

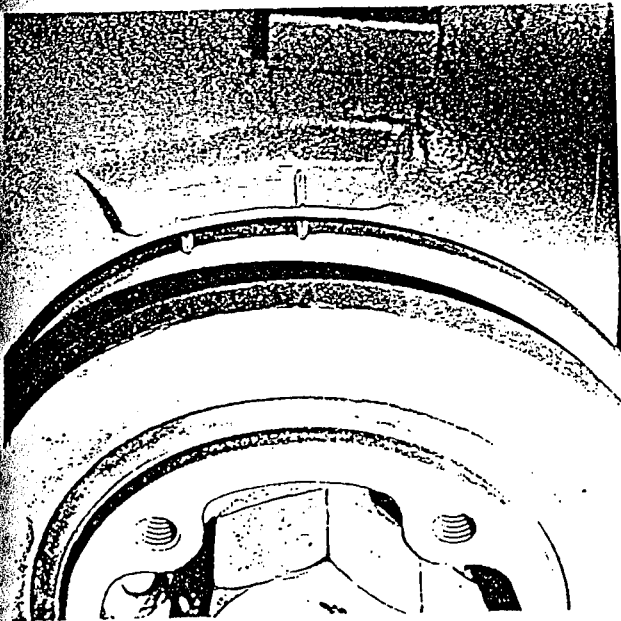

104. On the MD21, the No. 4 exhaust valve is removed as follows: Release the adjuster nut and screw up the screw. Then press the rocker arm against the spring and place tool 884473 on the valve.

NOTE. Do not pull up the push rod since the valve lifter can accompany it and come at an angle.

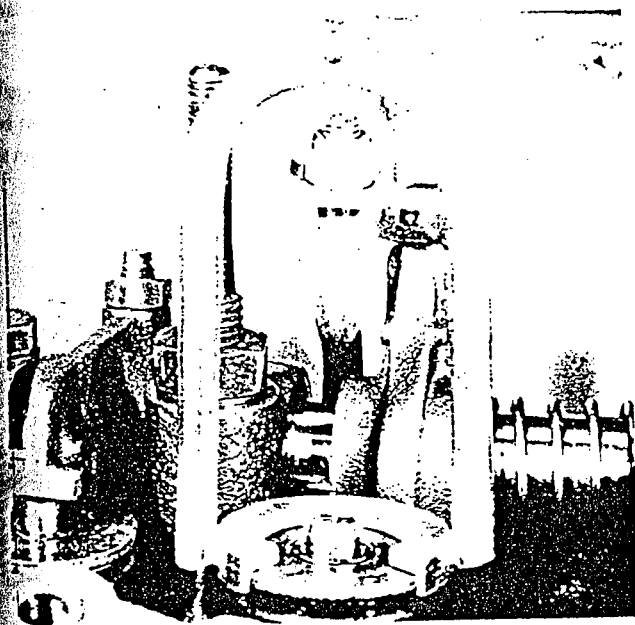

105. Remove the pump inspection cover (1) after having taken off the lead seal. Place a new gasket on the pump. Turn the pump pinion until the mark (2) on the rotor is seen in the round indicator hole (3). Fit the dial indicator on the pump and rotate the pump shaft so that the pointer on the gauge goes down into the groove on the rotor. This position is reached when the maximum reading is shown on the gauge or the pointer can swing no further. Fit the

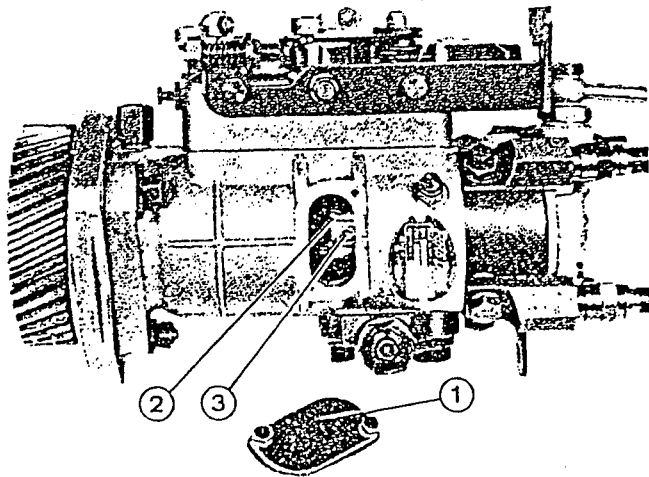

pump on the engine with the rotor turned so that the mark is seen immediately above the "indicator hole".

106. When the pump gear meshes, the mark will return to the adjustment in the center of the "indicator hole". Finally, fit the sea-water pump. NOTE. Make sure that the claws go into the fuel injection pump recess.

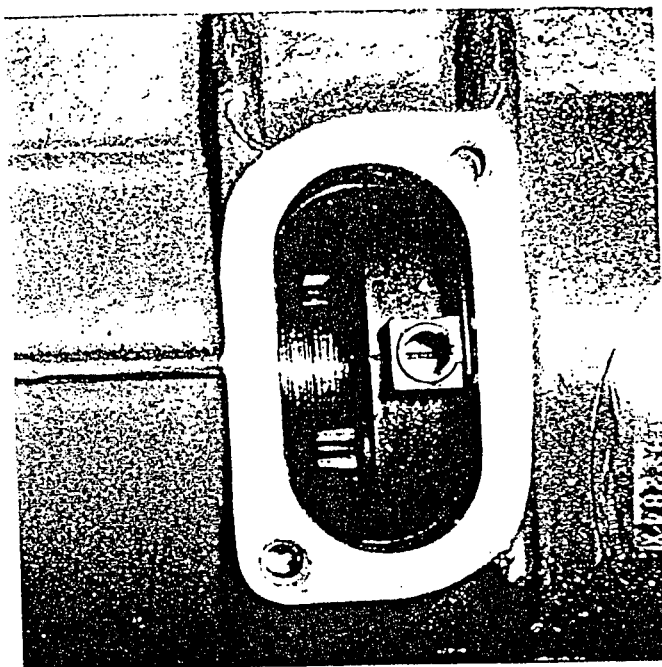

107. Remove the clearance in the timing gears and the pump parts with the lever (1, Fig. 107). Insert the point between the shaft (2) and the bolt head (3), then lift the yokelet upwards and hook the lever round the bolt (4) under the measuring gauge (5). If necessary, turn over the pump (after slackening the attacking bolts), to the proper position, that is, when the gauge pointer goes down into the

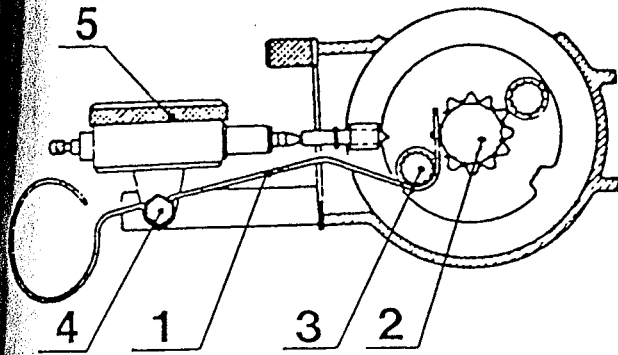

V-slot and the gauge gives maximum reading. Tighten up the pump again.

108. Remove the lever and turn over the engine 1/4 turn anti-clockwise and then slowly clockwise until injection begins. Re-fit the lever. The adjustment is correct when the measuring gauge gives maximum reading, top dead center, when the crankshaft is at the correct advanced injection value according to the table below. Re-adjust if necessary.

|                                | MD21             | MD32             |
|--------------------------------|------------------|------------------|
| Advanced injection angle       | 19°              | 16°              |
| Piston B.T.D.C. (valve stroke) | 2.87 mm (0.113") | 2.04 mm (0.080") |

After completing the adjustment, remove the dial indicator and re-fit the inspection cover. Lead-seal the pump. Re-fit the rocker arm and rocker casing.

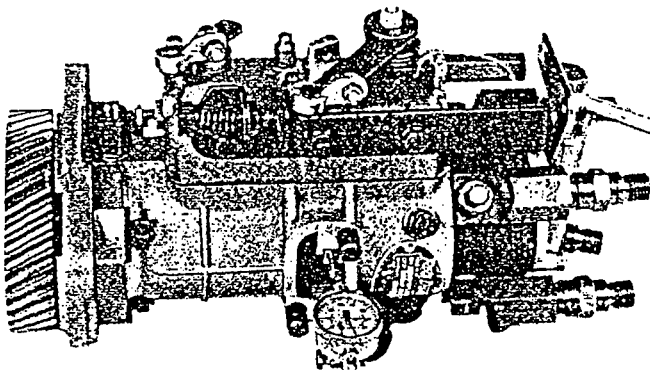

## Injectors

109. When pressure testing the injectors, the fuel should emerge as an ejected "mist screen". (See "Technical Data".)

The pressure can be adjusted by slackening the upper "nut" and inserting a screwdriver down into the hole and turning clockwise to increase the pressure and anticlockwise to decrease it. Then re-tighten the nut to a torque of 25 Nm (2.5 kpm = 18 lb.ft.). If many directed jets emerge or oil drips from the injector, the injector must be scrapped. Fit a new one and adjust it. When replacing the injector nozzle,

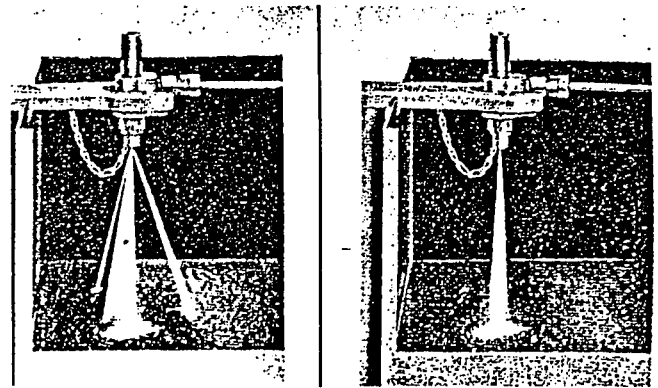

Wrong

Right

re-tighten the injector nut to a torque of 65 Nm (6.5 kpm = 47 lb.ft.).

110. Place new copper washers (1) in the holes for the injectors and fit the injectors. Fit the yoke and screw on the nuts with their washers. Fit the injector pipes before finally tightening up the yokes.

When the pipes are tightened, tighten up the yokes to a torque of 20 Nm (2.0 kpm = 14 lb.ft.). NOTE. Tighten the nuts evenly so that the yokes do not fit at an angle.

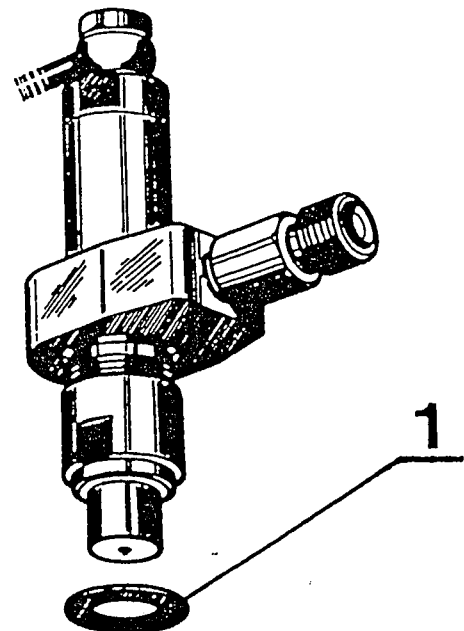

## Glow plugs

111. Remove and check the plugs.

The glow plugs are single-pole and connected in parallel.

Troubleshooting table

| Engine                              | Control resistor              | Glow plugs                                |
|-------------------------------------|-------------------------------|---|
| Runs normally                       | Dark red or amber             | Good condition                            |
| Easy to start                       |                               |   |
| Difficult to start<br>(See A below) | Glow slightly or not at all   | Glow coil on one or several plugs damaged |
| Does not start<br>(See B below)     | Glow white and starts melting | Short circuit in elec system or plugs     |

On late prod. type engines, the control resistor is located on the engine. The resistor for the MD21 is placed above the alternator on the starboard side. On the MD32, the resistor is placed on the port side above the starter motor. In order to check the resistor, remove it from the engine, but do not disconnect it from the circuit. The troubleshooting procedure is the same as for the early prod. type. See Table.

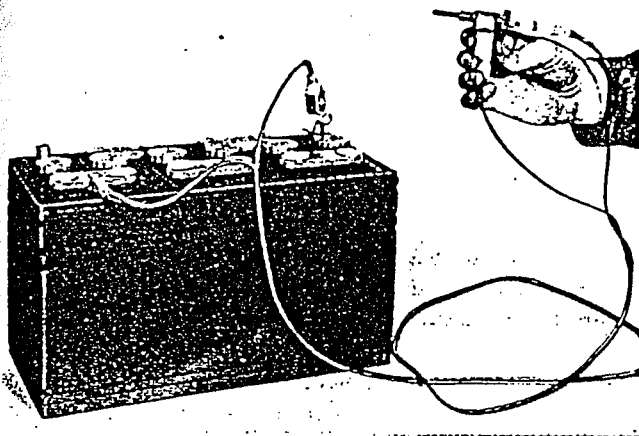

### A Plug's glow coil does not function

If it is suspected that the glow coil on one or several plugs is damaged, disconnect the connection cable, and then wire a control lamp in series with the plug. If the lamp lights, then the plug is in good condition. If the lamp does not light, then the plug is damaged.

### B Short circuit in plug

Remove the plugs, one at a time. Connect a 12 V battery to a plug, a clamp on the plug mantle and one on the pole, see Fig. If the holder becomes warm, the plug is in good condition.

Then check the other plugs.

Before glow plugs are re-fitted, their threads should first be greased with graphite grease, as this will make subsequent removal of the plugs easier.

Tightening torque = 45 Nm (4.5 kpm = 32 lb.ft.).

Fit the electric bar and tighten up the nuts with a screwdriver. Fit on the protective caps.

112. Fit the leak-off oil pipe (1). Use new packings both sides of the pipe connections. The banjo screws (2) should be tightened carefully. Fit the hose from the leak-off oil pipe to the fuel pump.

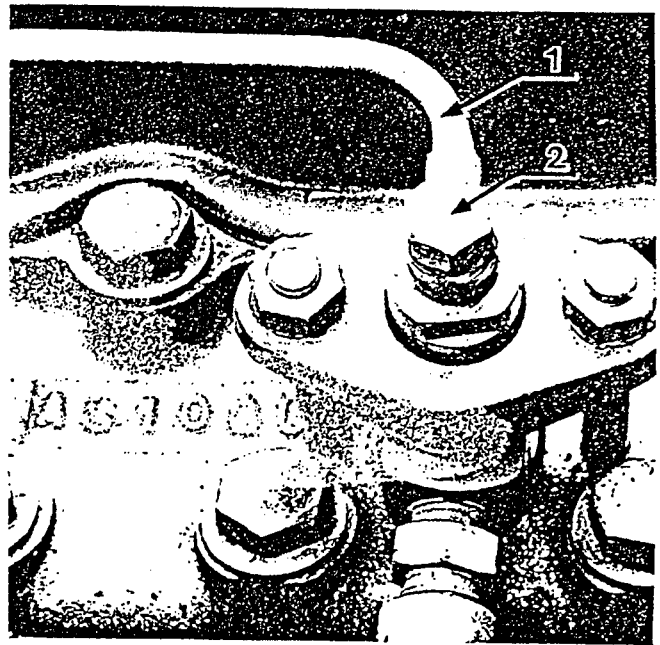

113. Fit the bracket for the control cable on the MD32. Use spring washers.

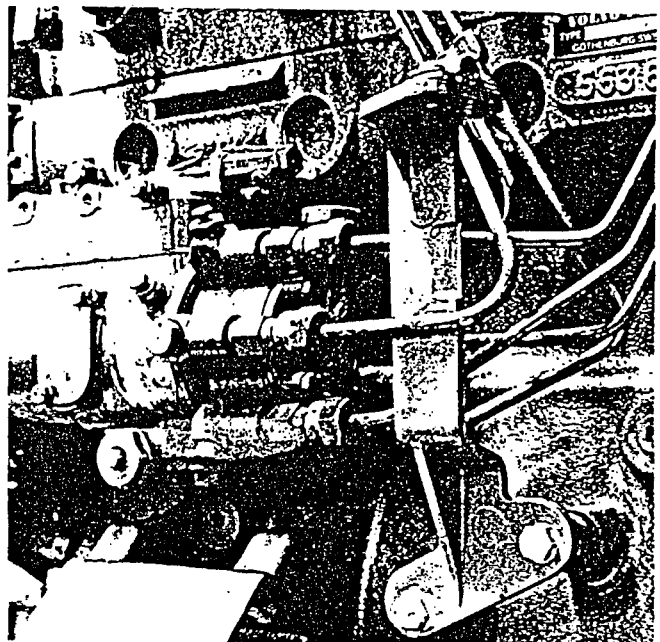

## Oil cooler

114. Remove the oil cooler and clean off seaweed, shells and other impurities that can cause poor water circulation, which would result in overheating. Assemble the oil cooler and new O-rings.

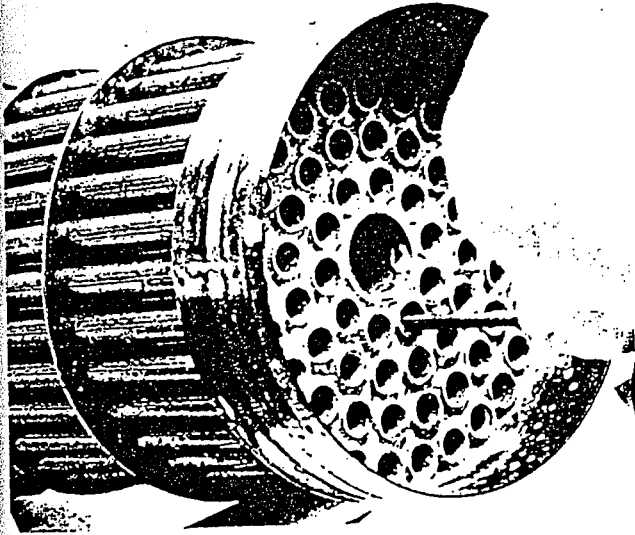

115. Fit the oil cooler on the engine with a new gasket and install a new oil filter.

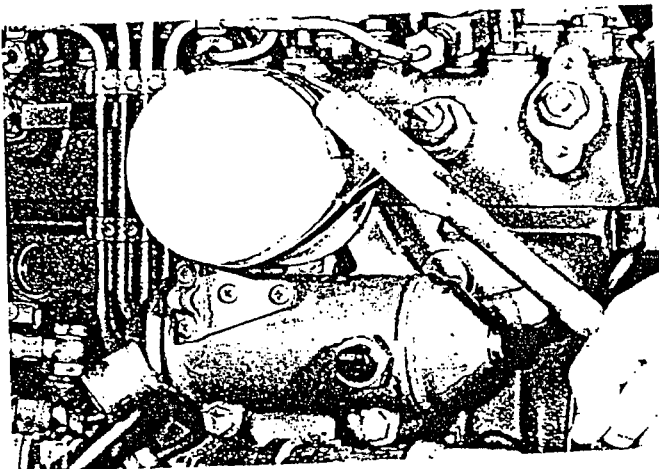

116. Screw the drain cock onto the block. Fit the starter motor. The lower bracket has a nylock nut.

117. Fit the pipe for the oil dipstick with new washer. Insert the dipstick.

118. Fit the engine speed sender. Check that the teeth and nylon pin are in good condition. Lubricate the gear wheel well.

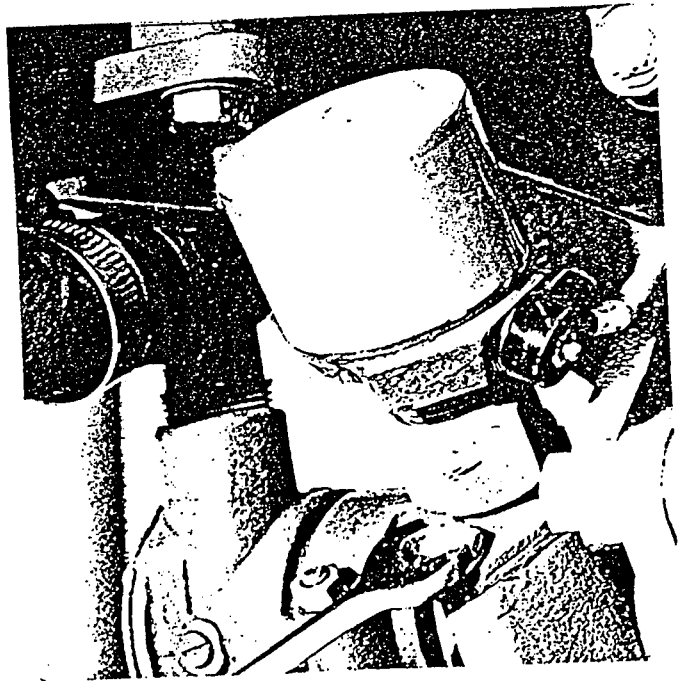

119. Fit the pipe between the oil cooler and the sea-water pump. Tighten up the hose clamps well.

120. Connect up the oil pipes (from the feed pump) to the fuel filter and from the filter to the fuel injection pump. Remove the check valve from the fuel filter in hole No. 3 and clean the valve. Screw back the check valve into position. Tighten up the fuel filter.

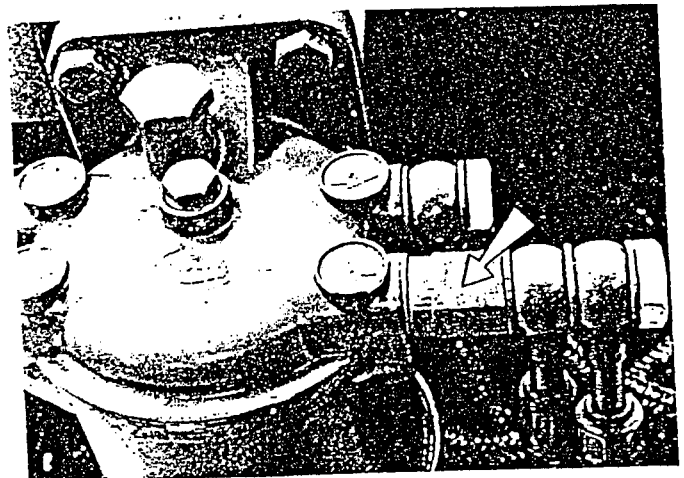



121. Fit the alternator and charging regulator. Bind up the cable harness to prevent the cables from getting frayed or damaged in any other way. Fit on the drive belt and tension it by means of the alternator so that it is just possible to depress the belt midway a couple of mm. NOTE. With regard to a dynamo, it should be possible to depress the belt midway about 10 mm (3/8"). Tighten securely the alternator (dynamo). Connect up the cables.

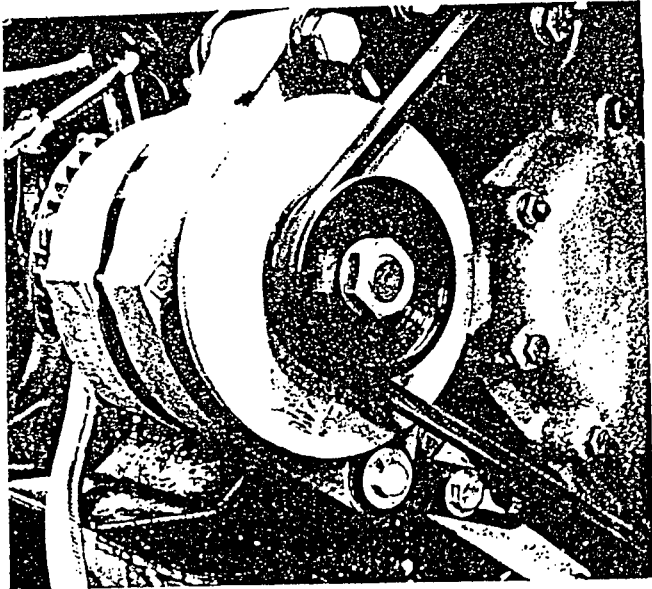

122. Check to make sure that all oil pipes and cables are properly fitted on their brackets.

123. Fit the pipe for the oil scavenging pump.

124. Fit the exhaust elbow with a new packing. Tighten up the bolt inside the exhaust pipe and lock it with lock wire, before tightening up the four outside bolts. The oil scavenging pump is fixed in position by two of the bolts.

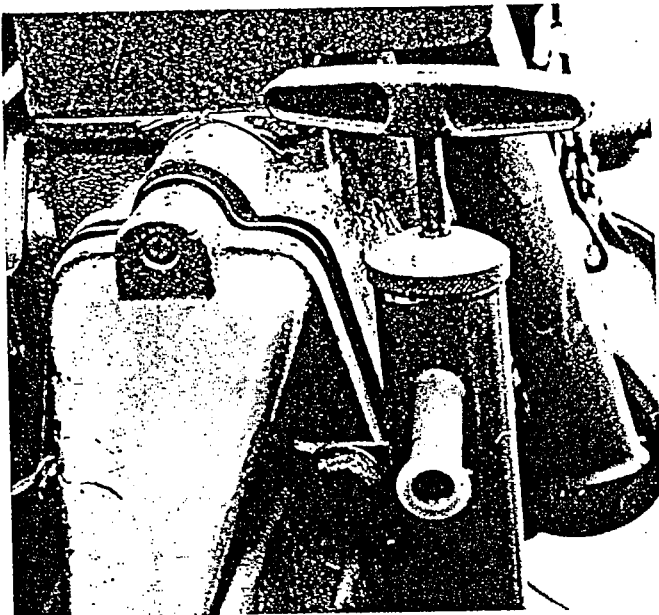

125. Fit the intake silencer after cleaning and blowing dry the gauzes in the snorkles. Press on the rubber hose between the intake silencer and the oil filler cap.

126. Close all drain cocks. Replace the fuel filter insert and fit the filter on the bracket. Bleed the fuel system. Fill the engine with oil and water. Concerning oil quality, viscosity and bleeding of the fuel system, see the Instruction Book.

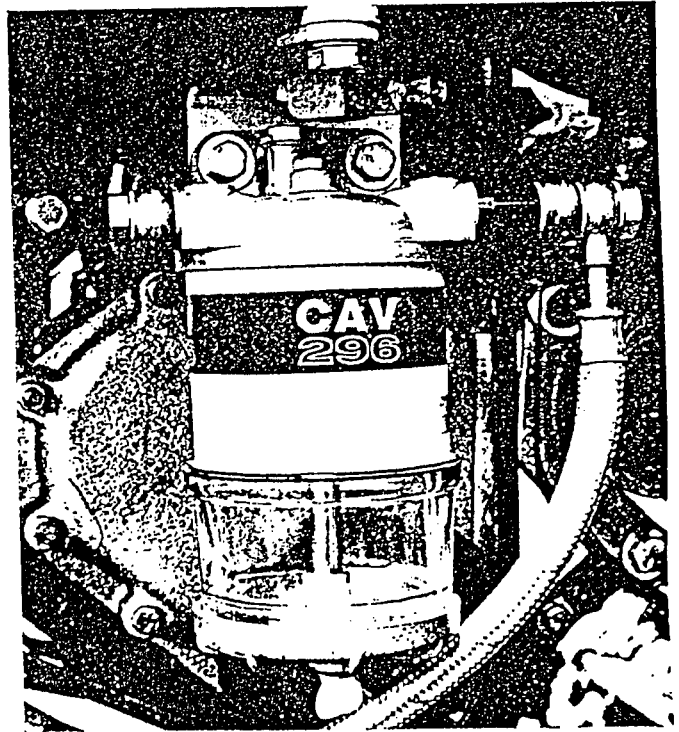

127. Test-run the engine and carry out all check points indicated in the Warranty Certificate under "Delivery Service".

wiring diagram: Engine

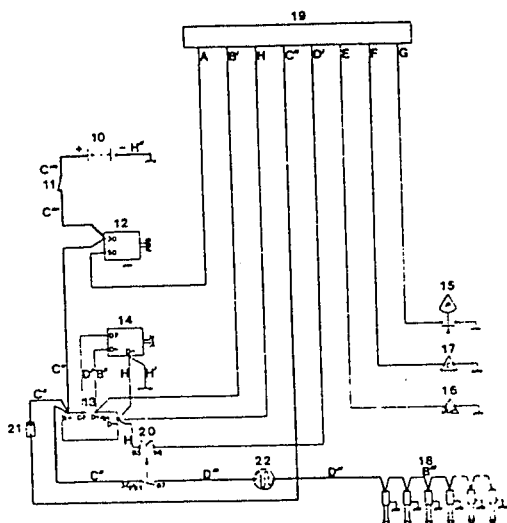

4-cyl. engine with dynamo

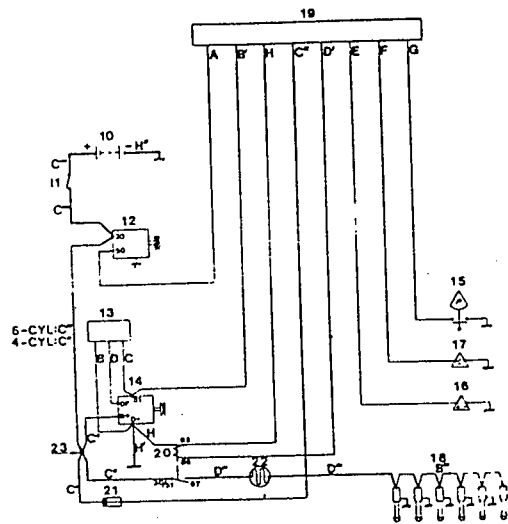

4- and 6-cyl. engines with alternator

LIST OF COMPONENTS, ENGINE

- 10. Battery
- 11. Master switch
- 12. Starter motor
- 13. Charging regulator
- 14. Alternator or dynamo
- 15. Oil pressure sensor
- 16. Engine speed sender
- 17. Temperature sender
- 18. Glow plugs
- 19. Connector
- 20. Relay for glow plugs
- 21. Fuses
- 22. Control resistor
- 23. Coupling

CABLE MARKINGS

| Mark  | Colour | sq. mm | AWG |
|-------|--------|--------|-----|
| A     | White  | 6      | 9   |
| B     | Black  | 0.6    | 19  |
| B'    | Black  | 1.5    | 15  |
| B''   | Black  | 4      | 11  |
| B'''  | Black  | 6      | 9   |
| C     | Red    | 0.6    | 19  |
| C'    | Red    | 2.5    | 13  |
| C''   | Red    | 6      | 9   |
| C'''  | Red    | 10     | 7   |
| C'''' | Red    | 50     | 0   |
| D     | Green  | 0.6    | 19  |
| D'    | Green  | 1.5    | 15  |
| D''   | Green  | 2.5    | 13  |
| D'''  | Green  | 6      | 9   |
| E     | Gray   | 1.5    | 15  |
| F     | Yellow | 1.5    | 15  |
| G     | Brown  | 1.5    | 15  |
| H     | Blue   | 1.5    | 15  |
| H'    | Blue   | 4      | 11  |
| H''   | Blue   | 50     | 0   |

Warning

Never break the circuit between the alternator and battery while the engine is running. To do this would be to ruin the charging regulator diodes immediately. The master switch must never be switched off until the engine has stopped completely.

Wiring diagram: Instrument panels

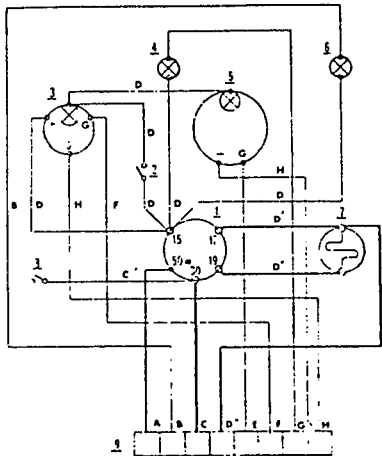
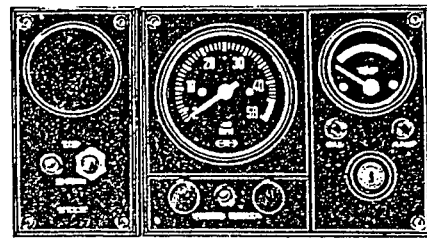
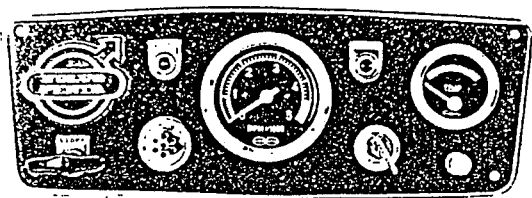

Instrument panel, 4-cyl. and 6-cyl. engines  
Early prod.

COMPONENTS, INSTRUMENT PANEL

1. Key switch
2. Switch for instrument panel lighting
3. Temperature gauge
4. Warning for low oil pressure
5. Speedometer
6. Battery charging warning lamp
7. Control resistor
9. Connector

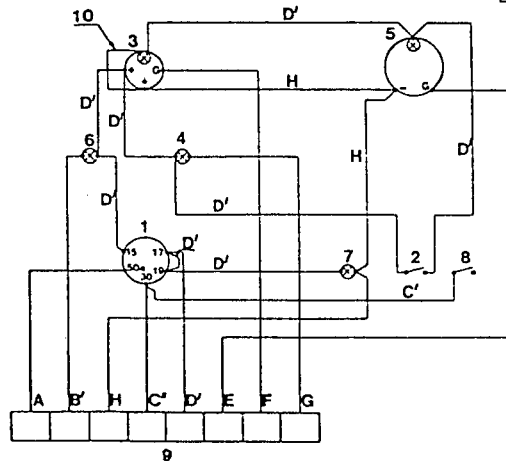

Instrument panel, 4-cyl. and 6-cyl. engines  
Late prod.





COMPONENTS, INSTRUMENT PANEL

1. Key switch
2. Switch for instrument panel lighting
3. Temperature gauge
4. Warning for low oil pressure
5. Speedometer
6. Battery charging warning lamp
7. Warning lamp for switching on glow plugs
8. Switch (optional)
9. Connector
10. For 24 V

CABLE MARKINGS

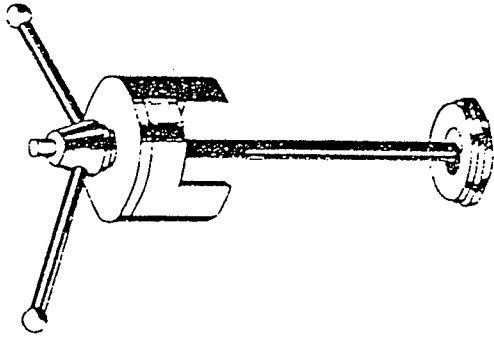
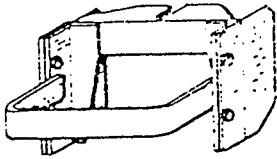
| Mark | Colour | sq.mm | AWG |
|------|--------|-------|-----|
| A    | White  | 6     | 9   |
| B    | Black  | 0.6   | 19  |
| B'   | Black  | 1.5   | 15  |
| C    | Red    | 0.6   | 19  |
| C'   | Red    | 2.5   | 13  |
| C''  | Red    | 6     | 9   |
| D    | Green  | 0.6   | 19  |
| D'   | Green  | 2.5   | 15  |
| D''  | Green  | 2.5   | 13  |
| E    | Gray   | 1.5   | 15  |
| F    | Yellow | 1.5   | 15  |
| G    | Brown  | 1.5   | 15  |
| H    | Blue   | 1.5   | 15  |

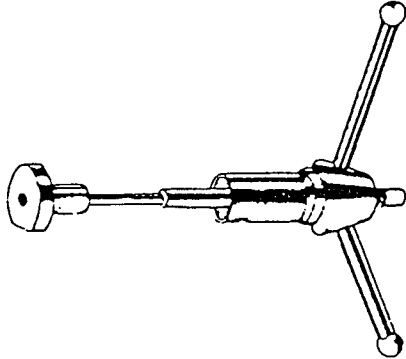
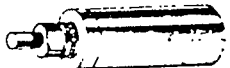
Special tools for AOD21, MD21 – AOD32, MD32

| Part No. | Description   | Engine type |             |
|----------|---|-------------|-------------|
|          |   | AOD21, MD21 | AOD32, MD32 |
| 884230   |  <p>Wrench for cylinder head bolts</p>               | x           | x           |
| 884231   |  <p>Cylinder liner extractor</p>                     | x           | x           |
| 884232   |  <p>Tool for fitting seal at rear main bearing</p>  | x           | x           |
| 884235   |  <p>Tool for fitting seal at rear main bearing</p> | x           | x           |
| 884236   |  <p>Tool for fitting valve guides</p>              | x           | x           |
| 884237   |  <p>Extractor for idler gear shaft</p>             | x           | x           |
| 884238   |  <p>Plug wrench 5 mm</p>                           | x           | x           |
| 884239   |  <p>Plug wrench 6 mm</p>                           | x           | x           |

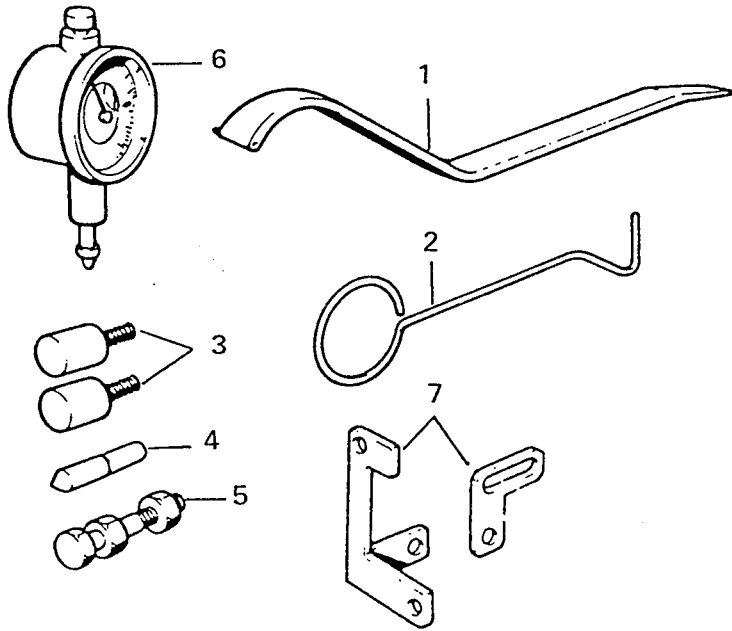

884299

1. Tool for adjusting fuel flow (used only when testing on diesel test bench)
2. Lever for removing clearance
3. Screws for attaching holder
4. Extension pin for dial indicator
5. Bolt for holding dial indicator
6. Dial indicator
7. Holding brackets

Tool kit complete for fitting CAV. ROTO-DIESEL fuel injection pumps

x x

884308



Bleeder screw

x x

884309

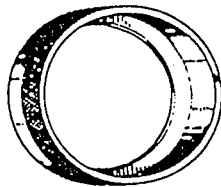

Fitting ring, piston (std.)

x x

884473

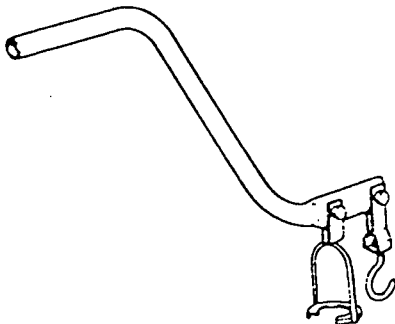

Tool for removing valve spring retaining holders in connection with pump adjustment

x x

884382



Lock screws for attaching liner when measuring

x x

884384

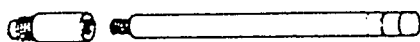

Dollies for cylinder heads

x x

# Technical Data

## General

|   |                   |                  |
|---|-------------------|------------------|
| Type designation .....  | AQD21A, MD21A     | AQD32A, MD32A    |
| Engine type .....   | Indenor XDP 4/90  | Indenor XDP 6/90 |
| Max. output, pleasure boats, SAE at 75 r/s<br>(4500 r/m) .....            | 55.2 kW (75 h.p.) | 78 kW (106 h.p.) |
| Bore, mm (in.) .....  | 90 (3.54)         | 90 (3.54)        |
| Stroke, mm (in.) .....  | 83 (3.27)         | 83 (3.27)        |
| Capacity, total, dm <sup>3</sup> /liter (cu.in.) .....                    | 2.11 (129)        | 3.17 (193)       |
| Compression ratio .....   | 22.1:1            | 22.1:1           |
| Compression pressure at starter motor r/m, kp/cm <sup>2</sup> (psi) ..... | 24-27 (341-384)   | 24-27 (341-384)  |
| Firing order, No. 1 cylinder nearest flywheel .....                       | 1-3-4-2           | 1-5-3-6-2-4      |
| Max. speed, unloaded engine, pleasure boats, r/s (r/m) .....              | 81 (4850)         | 73 (4350)        |
| Max. idling speed, r/s (r/m) .....  | 11 (650)          | 11 (650)         |

## Cylinder liners

|                       |                  |
|-----------------------|------------------|
| Cylinder liners ..... | Wet, replaceable |
|-----------------------|------------------|

## Piston

|                                  |                           |
|----------------------------------|---------------------------|
| Material .....                   | Light-alloy               |
| Piston clearance, mm (in.) ..... | 0.09-0.12 (0.0035-0.0047) |

## Piston rings

|  |                           |
|--|---------------------------|
| Piston ring gap measured in ring opening, mm (in.) .....               | 0.30-0.55 (0.0118-0.0216) |
| Piston ring gap measured in ring opening (U-Flex ring), mm (in.) ..... | 0                         |

## Compression rings

|   |                             |
|---|-----------------------------|
| Upper ring chromium-plated                  |                             |
| Number on each piston .....                 | 3                           |
| Height of compression rings, mm (in.) ..... | 1.990-2.022 (0.0783-0.0796) |

## Oil scraper rings

|  |                            |
|--|----------------------------|
| Type .....                             | U-Flex                     |
| Ring height, mm (in.) .....            | 4.47-4.495 (0.1759-0.1769) |
| Number on each piston .....            | 1                          |
| Piston ring clearance in groove        |                            |
| No. 1 compression ring, mm (in.) ..... | 0.06-0.092 (0.0024-0.0036) |
| No. 2 compression ring, mm (in.) ..... | 0.04-0.072 (0.0016-0.0028) |
| No. 3 compression ring, mm (in.) ..... | 0.04-0.072 (0.0016-0.0028) |
| U-Flex ring, mm (in.) .....            | 0.015-0.06 (0.0006-0.0024) |

## Gudgeon pins

|  |                               |
|--|-------------------------------|
| Float journaling, circlips at both ends                |                               |
| Fit in connecting rod bushing, mm (in.) .....          | 0.013-0.026 (0.0005-0.0010)   |
| Fit in piston, mm (in.) .....                          | 0.003-0.009 (0.0001-0.0004)   |
| Gudgeon pin diameter, standard, mm (in.) .....         | 27.994-28.000 (1.1021-1.1024) |
| Connecting rod bushing, inner diameter, mm (in.) ..... | 28.020-28.007 (1.1031-1.1027) |

## Crankshaft

|  |                           |
|--|---------------------------|
| Replaceable bearing shells for main bearings and connecting rod bearings |                           |
| Crankshaft axial clearance, mm (in.) .....                               | 0.08-0.29 (0.0031-0.0114) |
| Crankshaft bearing, radial clearance, mm (in.) .....                     | 0.046-0.092 (0.0018-0.01) |

1) Moto-Meter gauge with nipple No. 67

Main bearings

AQD21A,MD21A

AQD32A,MD32A

Main bearing journals

|  |                               |
|--|-------------------------------|
| Standard, mm (in.)                         | 55-55.015 (2.1653-2.1659)     |
| Undersize, 0,30 mm (0.012 in.), mm (in.) : | 54.700-54.715 (2.1535-2.1541) |
| 0.50 mm (0.020 in.), mm (in.)              | 54.500-54.515 (2.1456-2.1462) |
| 0.80 mm (0.031 in.), mm (in.)              | 54.200-54.215 (2.1338-2.1344) |
| Standard bearing width, mm (in.)           | 37.76-37.81 (1.4866-1.4885)   |
| Thrust washer, standard, mm (in.)          | 2.30-2.33 (0.0905-0.0917)     |
| Thrust washer, oversize, mm (in.)          | 2.50-2.53 (0.0984-0.0966)     |

Big-end bearings

|   |                               |
|---|-------------------------------|
| Radial clearance, mm (in.)  | 0.045-0.086 (0.0018-0.0034)   |
| Big-end bearing journals, width, mm (in.) :                       | 36-36.1 (1.417-1.421)         |
| Big-end bearing journals, standard diameter, mm (in.)             | 49.99-50.006 (1.9681-1.9687)  |
| Big-end dbearing journals, undersize 0.30 mm (0.012 in.) mm (in.) | 49.690-49.706 (1.9563-1.9569) |
| undersize, 0.50 mm (0.020 in.), mm (in.)                          | 49.490-49.506 (1.9484-1.9490) |
| 0.80 mm (0.031 in.), mm (in.)                                     | 49.190-49.206 (1.9366-1.0372) |

Connecting rods

|  |                          |
|--|--------------------------|
| Marking to face towards injection side                                 |                          |
| Axial clearance at crankshaft, mm (in.)                                | 0.1-0.25 (0.0393-0.0098) |
| Only connecting rods of same class are to be fitted in the same engine |                          |
| Maximum permissible weight difference, grammes (ozs)                   | 40 (1.4)                 |
| Weight class 2 marked  | 5-4-3-2-1-A-B            |
| Weight class K marked  | I-J-K-L-M-N-O            |
| Weight class F marked  | C-D-E-F-G-H-I-J          |

Camshaft

|                                    |   |                               |   |
|------------------------------------|---|-------------------------------|---|
| Drive                              | 3 | Gear                          | 4 |
| Number of bearings                 |   |                               |   |
| Bearing journal diameter, mm (in.) |   | 41.925-41.950 (1.6505-1.6515) |   |
| End float, mm (in.)                |   | 0.05-0.15 (0.0020-0.0060)     |   |
| Radial clearance, mm (in.)         |   | 0.05-0.11 (0.0020-0.0043)     |   |

Camshaft bearings

|                           |                           |
|---------------------------|---------------------------|
| Bearings, diameter, (in.) | 42-42.039 (1.6535-1.6550) |
|---------------------------|---------------------------|

Timing gears

|   |                               |
|---|-------------------------------|
| Crankshaft drive, number of teeth               | 20                            |
| Idler gear, number of teeth                     | 44                            |
| Camshaft drive, number of teeth                 | 40                            |
| Drive gear for injection pump, number of teeth  | 40                            |
| Diameter of idler gear shaft, mm (in.)          | 28.98-27.993 (1.1015-1.1020)  |
| Bushing for idler gear inner diameter, mm (in.) | 28.007-28.020 (1.1026-1.1031) |
| Radial clearance for idler gear, mm (in.)       | 0.04-0.014 (0.0016-0.0006)    |
| End float for idler gear, mm (in.)              | 0.05-0.35 (0.0020-0.138)      |

Valve system

|  |                          |
|--|--------------------------|
| Valves                                 |                          |
| Inlet:                                 |                          |
| Valve head diameter, mm (in.)          | 40.3-40.5 (1.587-1.594)  |
| Stem diameter, mm (in.)                | 8.480-8.495 (0.33-0.334) |
| Valve seat angle in °                  | 45                       |
| Seat width, mm (in.)                   | 2.82-3.32 (0.011-0.013)  |
| Valve clearance, cold engine, mm (in.) | 0.15 (0.006)             |

|   |                                     |
|---|-------------------------------------|
| <b>Exhaust:</b>   |                                     |
| Valve head diameter, mm (in.)   | 33.3–33.5 (1.3110–1.3188)           |
| Stem diameter, mm (in.)   | 8.460–8.475 (0.3330–0.336)          |
| Valve seat angle in °   | 45°                                 |
| Seat width, mm (in.)  | 2.82–3.32 (0.111–0.131)             |
| Valve clearance, cold engine, mm (in.)                                    | 0.25 (0.0098)                       |
| <b>Valve seats</b>  |                                     |
| <b>Valve seats for inlet valves:</b>                                      |                                     |
| Diameter standard (A), mm (in.)   | 42.146–42.171 (1.6592–1.6603)       |
| Oversize 1 (A), mm (in.)  | 42.346–42.371 (1.6671–1.6681)       |
| Oversize 2 (A), mm (in.)  | 42.646–42.671 (1.6789–1.6799)       |
| Height (B), standard, mm (in.)  | 5.90–6.10 (0.2322–0.2401)           |
| Height (B), oversize, mm (in.)  | 6.25–6.35 (0.2460–0.2500) inlet val |
| <b>Valve seat location, inlet valves:</b>                                 |                                     |
| Diameter, standard (C), mm (in.)  | 41.975–42.025 (1.6525–1.6545)       |
| Oversize 1 (C), mm (in.)  | 42.175–42.225 (1.6604–1.6624)       |
| Oversize 2 (C), mm (in.)  | 42.475–42.525 (1.6722–1.6742)       |
| Depth, standard (D), mm (in.)   | 8.4–8.6 (0.3307–0.3386)             |
| Depth, oversize (D), mm (in.)   | 8.7–8.9 (0.3425–0.3504)             |
| Location, bottom radius   | Acute angle                         |
| <b>Valve seats, exhaust valves:</b>                                       |                                     |
| Diameter, standard (A), mm (in.)  | 36.122–36.147 (1.4221–1.4231)       |
| Oversize 1 (A), mm (in.)  | 36.322–36.347 (1.4299–1.4309)       |
| Oversize (A), mm (in.)  | 36.622–36.647 (1.4418–1.4428)       |
| Height (B), standard, mm (in.)  | 5.90–6.10 (0.2322–0.2401)           |
| Height (B), oversize, mm (in.)  | 6.25–6.35 (0.2460–0.2500)           |
| <b>Valve seat locating, exhaust valves:</b>                               |                                     |
| Diameter, standard (C), mm (in.)  | 35.975–36.025 (1.4163–1.4183)       |
| Oversize 1 (C), mm (in.)  | 36.175–36.225 (1.4242–1.4262)       |
| Oversize 2 (C), mm (in.)  | 36.475–36.525 (1.4360–1.4380)       |
| Depth, standard (D), mm (in.)   | 8.4–8.6 (0.3307–0.3386)             |
| Depth, oversize (D), mm (in.)   | 8.7–8.9 (0.3425–0.3504)             |
| Location, bottom radius   | Acute angle                         |
| NOTE. Measurement between the valve head and cylinder head face, mm (in.) | 0.75–1.15 (0.0295–0.0453)           |
| <b>Valve guides</b>   |                                     |
| Length, guide for inlet valve, mm (in.)                                   | 55 (2.1654)                         |
| Length, guide for exhaust valve, mm (in.)                                 | 55 (2.1654)                         |
| Inner diameter, inlet/exhaust valves, mm (in.)                            | 8.520–8.542 (0.3354–0.3363)         |
| Measured from cylinder head face to valve guide, mm (in.)                 | 27.5–28.5 (1.0827–1.1220)           |
| <b>Valve springs</b>  |                                     |
| <b>Inner springs</b>  |                                     |
| Length, off load, approx. mm (in.)  | 41 (1.6141)                         |
| Length (valve closed) with 7.6 kg (17 lb.) load, mm (in.)                 | 31 (1.2204)                         |
| Length (valve open) with 15.8 kg (35 lb.) load, mm (in.)                  | 21.5–22.5 (0.8464–0.8858)           |
| Length, compressed spring, mm (in.)                                       | 20.0 (0.7874)                       |



Outer springs

|  |                           |
|--|---------------------------|
| Length, off load, approx. mm (in.)                         | 44.6 (1.7559)             |
| Length (valve closed) with 22.2 kg (49 lb.) load, mm (in.) | 34.5-35.5 (1.3582-1.3976) |
| Length (valve open) with 46 kg (101 lb.) load, mm (in.)    | 25.5-26.5 (1.0039-1.0433) |
| Length, compressed spring, mm (in.)                        | 24 (0.9449)               |

Fuel system

|   |  |
|---|--|
| Injection pump, direction of rotation viewed from flywheel side | Anticlockwise                            |
| Injection sequence  | 1-3-4-2                      1-5-3-6-2-4 |

Fuel injection pump

|                                      |  |
|--------------------------------------|--|
| Flange mounted to timing gear casing |  |
| Fuel injection pump, make and type   | CAV Roto-Diesel/DPA                            |
| Type number                          | 4.90/4850                      6.90/4350       |
| Adjusting cylinder                   | 4                                      6       |
| Adjusting angle, °B.T.D.C.           | 19                                      16     |
| Adjusting angle, mm (in.)            | 2.87 (0.113)                      2.04 (0.080) |

Feed pump

|      |          |
|------|----------|
| Make | GUIOT    |
| Type | UY-521 A |

Injectors

|   |  |
|---|--|
| Make  | ROTO-DIESEL  |
| Type  | RDN-12SD-6517                      RDN-OSD-21  |
| Injector opening pressure, kp/cm <sup>2</sup> (psi) | 129.5-130.5                      119.5-120.5<br>(1841-1855)                      (1699-1714) |

Glow plugs

|      |            |
|------|------------|
| Make | Bosch      |
| Type | KE/GSA 9/1 |

Lubricating system

|  |                              |                              |
|--|------------------------------|------------------------------|
| Oil quantity, incl. filter, dm <sup>3</sup> /liters (imp. qts = US qts.) | 5.5 (4.8=5.8)                | 8 (7 = 8.4)                  |
| Oil pressure, warm engine (max r/m), kp/cm <sup>2</sup> = psi            |                              | 2.8-3 (40-43)                |
| Oil pump   |                              | Gear type                    |
| Number of teeth  |                              | 6                            |
| Tooth backlash, mm (in.)   | 0.16-0.26<br>(0.0062-0.0102) | 0.17-0.27<br>(0.0067-0.0106) |
| Clearance between teeth and housing, mm (in.)                            |                              | 0.02-0.06 (0.0008-0.0024)    |

Teghtening torques

|   |                 |                |
|---|-----------------|----------------|
| Cylinder heads, Nm (kpm = Lbft.)          | 100 (10.0 = 72) |                |
| Main bearings, Nm (kpm = Lbft.)           | 60 (6.0 = 43)   |                |
| Big-end bearings, Nm (kpm = lb.ft.)       | 65 (6.5 = 47)   |                |
| Flywheel, Nm (kpm = Lbft.)                | 45 (4.5 = 32)   |                |
| Glow plugs, Nm (kpm = lb.ft.)             | 170 (17=123)    | 210 (21 = 152) |
| Crankshaft pulley, Nm (pkm lb.ft.)        | 65 (6.5 = 47)   |                |
| Injector holders, Nm (kp = lb.ft.)        | 25 (2.5 = 18)   |                |
| Nuts for injector pipes, Nm (kpm = Lbft.) | 35 (3.5 = 25)   |                |
| Nut for pulley, Nm (kpm = lb.ft.)         | 20 (2.0 = 15)   |                |
| Injectors, attaching nuts                 |                 |                |

*70 (7.0 = 50) 75 Nm.*

# Troubleshooting Scheme

| Engine does not start | Engine stops | Engine does not reach right rpm at full gas (hunts) | Engine uneven or vibrates abnormally | Engine becomes abnormally warm | FAULT   | REMEDY   |
|-----------------------|--------------|---|--------------------------------------|--------------------------------|---|--|
| X                     |              |   |                                      |                                | Master switch not switched on; flat battery, breakage in electric cables.                       | Check specific gravity of battery acid with hydrometer. Check cable connections.   |
| X                     | X            |   |                                      |                                | Empty fuel tank, shut fuel cock, clogged fuel filter. Air leakage in fuel system.               | See Instruction Book for cleaning of fuel filter and bleeding fuel system. Check joint nipples and connections in fuel system.   |
| X                     | X            |   | X                                    |                                | Water or impurities in fuel. Defective injectors.   | See pages 24 and 31. See page 28.  |
| X                     |              |   |                                      |                                | Defective spark plug.   | See page 29.   |
|                       |              | X   |                                      |                                | Defective rev counter.  | Check the rev counter.   |
|                       |              | X   | X                                    |                                | Damaged propeller.  | See instruction Book.  |
|                       |              | X   |                                      |                                | Boat abnormally loaded.   | If possible spread out load to obtain a better and easier running.   |
|                       |              | X   |                                      |                                | Marine growth on boat bottom and outboard drive.  | Note! When the boat has been in the water for some time, the max. engine speed can drop due to marine growth on the boat bottom and outboard drive. Use anti-fouling paint (must not contain copper or mercury). Check and clean boat bottom and outboard drive regularly. |
|                       |              |   |                                      | X                              | Blockage in cooling water intake, oil cooler, cooling jackets defective impeller or thermostat. | See page 8, points 16, 17. See page 20, points 80. See page 30, point 114.   |
|                       |              | X   |                                      |                                | Clogged gauze in intake silencer.   | Remove the intake silencer and wash it in white spirit or similar. Blow clean the gauze in the snorkles, and check to make sure the gauze is absolutely clean.   |
|                       |              | X   |                                      |                                | Poor flow through fuel lines.   | 1 Check to make sure fuel lines are free from impurities   |
|                       |              | X   |                                      |                                | Wrong feed pressure.  | 2 Connect a low-scale pressure gauge to the inlet pipe on the fuel injection pump. Feed pressure should be 0.1 kp/cm <sup>2</sup> (14 psi) at full speed and load. If the pressure drops to 0 or below 0, then carry out points 1-6.                                       |
|                       |              | X   |                                      |                                | Clogged strainer in feed pump.  | 3 Check and clean the strainer in the feed pump  |
|                       |              | X   |                                      |                                | Fine filter clogged.  | 4 Check and clean the fine filter. Change filter insert.   |
|                       |              | X   |                                      |                                | Relief valve not functioning.   | 5 Check and if necessary change the relief valve.  |
|                       |              | X   |                                      |                                | Feed pump not functioning.  | 6 Change feed pump rubber diaphragm or the entire pump if it is worn.  |